



NICOLS

2025



DON'T FOLLOW THE FLOW

France | Germany | Portugal | Netherlands | Hungary | Ireland





AHOY THERE!

1986-2025



We've been proudly providing our customers with unforgettable boating holiday experiences for nearly 40 years now. Our mission remains to introduce as many people as possible to the wonderful world of life on the waterways.

GO WHERE NO ONE EXPECTS US.

For a one-of-a-kind holiday, far from the usual tourism crowds.
Choose a self-drive boating holiday,
On some of Europe's finest rivers and canals.

Escape amongst beautiful scenery and nature.
Embrace peace, quiet, serenity,
And treasure time with family or friends.

Imagine a new way to travel – a slow pace of life.
Cast off and be carried along with the flow of waterways,
Let yourself be surprised every day by new discoveries.

Onboard a Nicols boat, built by our own craftsman in France.
Fully-equipped with every home-from-home comfort you'll need,
Our teams are ready to welcome you – for the holiday of a lifetime.

We promise you an unforgettable journey.



THE 10 GOOD REASONS TO TRAVEL WITH NICOLS



- All our boats are made in our shipyard **in France**.
- **Smart and bright** house boats.
- Family friendly boats where **safety is paramount**.
- Small bases with **knowledgeable and friendly staff**.
- Innovation: **The first to develop electric powered boats**.
- **25% of the fleet is equipped with air-conditioning**.

- **Excellent savings** for our loyal customers.
- Cruising itineraries on **the most beautiful waterways in France and in Europe**.
- **A welcome present** waiting for you on arrival aboard.
- And lastly.... **our heated pool** (exclusive to Nicols) perfect for children... and for adults!



THE BEAUTY OF BOATING HOLIDAYS



If you're looking for an unusual holiday to share with family or friends, take the helm on a boating holiday and explore your destination by water as you discover the joys of life aboard your own cruiser. It's a truly memorable experience and there's no licence needed. A holiday on the waterways is not about going on an adventure... it's about enjoying a thousand and one little everyday adventures in the most beautiful of settings...

- **Simplicity:** whatever their size, all Nicols' boats are easy to drive and no previous experience or licence is needed. Turning a steering wheel and controlling the forward and reverse lever are all the skills necessary to manoeuvre them! All can be driven without a licence, in accordance with the legislation and regulations of waterways navigation. When it's time to collect your boat our base team will introduce you to the boat and show you just how easy it is.
- **Freedom:** choosing a river or canal boating holiday gives you complete freedom. Stop wherever and whenever you want – you're the captain!
- **Calm and serenity:** far from the noise of the cities, far from crowds and mass tourism, you'll be surrounded by the tranquillity of open green spaces as the slow rhythm of the waterways helps you rediscover the pleasure of taking your time.
- **Closeness to nature:** open your eyes to the fauna and flora around you as you journey through the heart of nature and enjoy the sights and sounds that each season offers. There really is no better way to escape the hustle and bustle of your usual everyday routine.
- **Discovery of heritage and gastronomy:** each village and town along your route is full of cultural treasures. Visit the many castles and museums of your chosen region and be sure to discover delicious local food and drink. You're sure to find some gastronomic delights in the markets or at the table of a good restaurant. And, of course, don't forget the vineyards!
- **Activities for all ages:** swimming, fishing, walking, cycling on the towpaths or simply rest and relaxation and things like picnics at the water's edge... there's plenty to keep everyone entertained. Young or old, holidaymakers on a canal boat are never bored!

First boating holiday? No problem!

• If you've never set foot onboard before then you're bound to have a thousand and one questions. Are you wondering how to get through a lock? Or maybe you don't know how to prepare for your holiday, how to plan where and when to stop, or quite simply... what to pack in your suitcases?

Help is at hand so get in touch with our experts or visit the Nicols website to find all the answers to your questions.

EVEN MORE TO ENJOY...

Make your holiday extra special! Nicols offers the following extras...
To guarantee these optional extras we recommend booking them as soon as possible.



BICYCLES

Bikes are available to hire from all of our bases and provide extra flexibility for exploring the area where you've moored, little villages, places of interest or simply for going to buy your daily bread.

A helmet is mandatory for children under 12 years of age: please remember to bring your equipment.

FISHING

Your boat is a great vantage point for fishing from. You can fish in the canals and rivers providing you hold a fishing licence. These can be purchased from local fishing tackle shops or on the web (www.cartedepeche.fr).

As a guide, a 7-day licence for fishing will cost around 35 € in France and 40 € in Germany. In Portugal it's a one off cost of 25 € regardless of the length of your holiday.



BARBECUE

Hire all of the equipment you'll need to enjoy a barbecue, then simply pick up your food fresh from the many mooring places you'll find on route. Take it on board with you...most of our bases even offer rental of gas bottles. As with all barbecues please be careful and familiarise yourself with all the equipment before departure.



WIFI

Whether it's your tablet, laptop or mobile phone... stay connected during your cruise! Most of our bases offer a Wifi service that will allow you to connect multiple devices simultaneously*. For more information please contact us.

**Subject to the quality of network coverage.
This varies by region.*

THE SWIMMING POOL

A Nicols exclusive. The on-board pool! Discover the pleasures of on-board bathing by adding one of our fantastic heated splash pools – simply tow it along with your boat. Suitable for the Estivale, Confort and Sedan (except Fly range, N800, Primo® and R920) ranges.

Technical description: Dimensions: 2,55 m x 3,10 m. Capacity: 700 litres, suitable for 3 people. Terrace with double safety rails. Converts into a larger terrace with two sliding covers. **Available in: Aquitaine, Charente, Midi.**

**If renting the splash pool for a boat of 13m or more a compulsory license is required.*



ANIMALS

Pets are welcome onboard. A supplement will be requested when you depart the base. Don't forget to bring their belongings (updated vaccination records, feeding bowl, bedding/blankets etc) and when travelling ensure that they remain safe and cannot cause any harm. Please be responsible for your pets behaviour and safety.



DECK MATTRESS

Enjoy additional onboard comfort with our deck mattress. Foldable and easy to store, the mattress is great for relaxing on the roof terrace or front deck of your Nicols boat.



ALL INCLUSIVE

The Nicols **ALL INCLUSIVE** option makes holiday planning easy with everything you need and more for a wonderful boating holiday. Let us do the hard work while you sit back and relax.

The all inclusive option includes: boat fuel + cleaning fee + 2 bikes + a waterways guide + 1 set of linen per person + 1 set of kitchen linen. For more information please contact us.



THE BEAUTY OF BOATING HOLIDAYS.

Our commitments for responsible holidays
& environmentally friendly.



By hiring a canal boat you are choosing a holiday set at **the heart of nature** so we know that wildlife and the countryside is important to you. The quality of the environment in which you will be navigating in contributes greatly to the enjoyment of your holiday, so between us let's protect it **together**. Our small actions... can have big effects!

How Nicols is helping the environment:



Nicols is committed to the preservation of the Canal du Midi: as a patron, we are participating in the replanting of trees along the Canal du Midi.



In 2018, Nicols created the first fully electric powered canal boat in Europe. For 2022, Nicols is continuing to add 'green' boats to the fleet with a second electric powered boat (details on page 48).



In Portugal, the entire Nicols fleet is equipped with solar panels.



Since 2019 Nicols has been part of APER, an eco-organisation in France created by the Federation of Nautical Industries, who promote eco-responsible activity on the waterways.



In 2024, Nicols will begin the conversion of its fleet to HVO power, a biodegradable fuel that **can reduce CO2 emissions by up to 90%**.

How you can help us protect nature:



Opt for using a train to get to the Nicols base. In France, more than half of **our bases are located less than 10km from a train station**.



When mooring, be careful not to damage the plant species around you.



Leave no trace of your visit: pick up your rubbish and dispose of it at the designated waste disposal services found on route. Also, try and think about sorting your waste – what might be able to be recycled?



Navigate gently and carefully so as not to damage or erode the river banks.



When collecting your boat Nicols will offer you a welcome kit including biodegradable cleaning products. If however you bring your own cleaning and hygiene products, you too should choose biodegradable products.



Water is a precious resource, but one which is needed for many different things: drinking water, fauna and flora, agriculture, fishing, boating holidays... To help save water we must limit situations where single boats pass through alone as much as possible. **Remember to group with other boats when passing through locks.**

Together, let's act as protectors of the environment.

WITH NICOLS, SET SAIL FOR SOME OF THE MOST BEAUTIFUL DESTINATIONS!



©IGN 2016 - licence ouverte

Nicols Bases

CONTENTS

FRANCE

- 12 • Brittany
- 14 • Anjou
- 16 • Charente
- 18 • Lot
- 20 • Aquitaine
- 22 • Midi
- 24 • Camargue
- 26 • Val de Loire • Nivernais

28 • Burgundy

- 30 • Franche-Comté • Saône
- 32 • Alsace

GERMANY

- 34 • Mecklenburg

NETHERLANDS

- 40 • Holland

IRELAND

- 36 • Shannon • Erne

HUNGARY

- 38 • Tokaj Lake • Tizja

PORTUGAL

- 42 • Lago Alqueva

OUR THEMED CRUISES

Nicols new themed cruises will help you choose the best suited itinerary to match your interests.



Food & Wine

Vineyards, wineries, tasting venues, restaurants offering prestigious local specialties and local produce tastings...



History & Heritage

Castles, religious buildings, classified sites, free tours to discover places of interest or hosted tours from the experts...



Flora & Fauna

Areas of natural beauty for fauna, flora and wildlife. Free tours to discover places of interest or hosted tours from the experts...

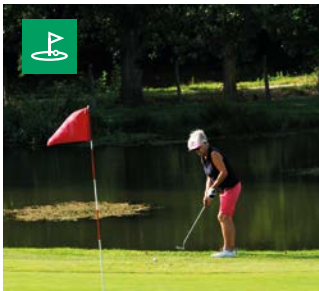

Golf

Mix your hobby of golf with a boating holiday. Some golf courses can even be found within walking distance of the waterways!



Swimming & Bathing

Natural and artificial lakes, easy beach access close to the river/canal, swimming pools and waterparks...



Fishing

In the canals, rivers, lakes and ponds! A holiday on the water is a fisherman's dream holiday...whether an amateur or enthusiast. What will you catch?



Family

Highlights any route with activities suitable for children and the whole family to enjoy. Zoo's, play areas, adventure parks and many more...

To help you with your choice, we've highlighted the 'must see' places to visit for every destination. (pages 12 to 43 of the brochure)



BRITTANY

Canal de Nantes à Brest - La Vilaine - L'Erdre



Glénac - L'Île aux Pies

At the crossroads of l'Erdre, la Vilaine and the Nantes to Brest Canal, discover the charms of Inland Brittany: waterways devoted entirely to pleasure cruising, its traditions, its seafood, delicious crepes and traditional cider!



HOLIDAY HIGHLIGHTS



LA GACILLY: exhibition of 30 years of crafts
JOSELIN: painting, sculpture, ceramics, leather, jewellery
LA ROCHE-BERNARD: art workshops in the old districts



Castles of the Dukes of Brittany (Nantes), castles at Blain and Josselin, castles dotted along the river Erdre Small towns with character: Malestroit, La Roche-Bernard, Josselin, Rochefort-en-Terre.



ÎLE AUX PIES: adventure trail
GUENROUËT: leisure park including mini-golf and waterslides
NANTES: the "Machines de l'Île" art project



Malestroit



Rennes



Nantes - Les machines de l'Île

OUR FAVORITE ROUTES

Duration	Our cruise suggestions	Km	Locks	Hours
2 Day Weekend	Glénac > Malestroit > Glénac	59	10	10h
1 Week	Glénac > Josselin > Rohan > Glénac	158	62	39h
Short break (One way)	Sucé / Erdre > Glénac	93	17	20h30
1 Week	Sucé / Erdre > La Roche Bernard > Sucé / Erdre	228	32	36h

Find all our courses on the Internet or contact us.

OUR CUSTOMERS' OPINIONS



→ Couples weekend - QUATTRO S
 from 14 - 16 June 2024

A getaway in the heart of nature!

«Although it was just a crew of two we had a great weekend. Apart from the swans and herons we pretty much had the River Vilaine to ourselves and the weather was superb. We needed a bit of practice to get used to driving the boat and do our first few manoeuvres but by using the instruction we'd received and by taking a bit of time it was soon plain sailing! We'd definitely do it again!»

Mathilde - Le Puy-Saint-Bonnet, France



THE OPINION OF OUR BRITTANY EXPERT

Three things to love about a holiday here:

- Glénac sits in an area classified as Natura 2000. You absolutely must go to Ile aux Pies, set between the cliffs of an old quarry. Poplars, fir trees and a multitude of other types of trees thrive here.
- On the River Vilaine, a stop off at Rieux is where you will be treated with a magnificent view of the river, valley and the entire region.
- Finally, for history buffs Saint Juste is located about 10km from the edge of the canal. It's a magnificent place, there's a kind of magic there. This prehistoric site can be visited all year round and, in summer, activities are offered on site.

Patrice, base at Glénac

ANJOU

La Mayenne - La Sarthe - L'Oudon



The beautiful and welcoming valleys of Anjou are just 2 hours and 30 minutes from Paris. A cruise on the Sarthe and Mayenne rivers takes you to the heart of the region's rich heritage with numerous castles, mills and character villages to explore. A boating holiday in this area a great option for those new to the waterways.



Solesmes- The abbey

HOLIDAY HIGHLIGHTS



ANGERS: the castle of King René
LE MANS: the historic quarter of the Plantagenet City
SOLESMES: the Benedictine Abbey



ÉCOUFLANT: Parc Anjou adventure park
JAILLE-SUR-YVON: tree top trek
SPAY: wake boarding watersports centre



ANGERS: plant life theme park "Terra Botanica"
ASNIÈRE: botanical garden with mosaic garden
SPAY ET CHÂTEAU-GONTIER: animal parks



Laval



Sablé / Sarthe



Grez-Neuville

OUR CUSTOMERS' OPINIONS



→ Family short break - NICOLS 1310
 from 25 - 29 August 2023

The perfect family break

«With three generations...grandparents, parents and children...this was the perfect opportunity to spend time together. We all had a fantastic time and the weather was good. Navigation on the waterways is very pleasant».

Jacques - Ternay, France



EVEN MORE COMFORT ON BOARD!

The whole fleet benefit from 1 quay plug 220 Volts and electric toilet and one USB port per cabin.



Malicorne's crockery

OUR FAVORITE ROUTES

Duration	Our cruise suggestions	Km	Locks	Hours
2 Day Weekend	Sablé > Malicorne > Sablé	52	10	10h
1 Week	Sablé > Angers > Grez > Sablé	168	20	29h
2 Day Weekend	Grez > Château-Gontier > Grez	62	18	10h30
1 Week (One way)	Grez > Segré > Angers > Malicorne > Sablé	175	27	28h

Find all our courses on the Internet or contact us.

THE OPINION OF OUR ANJOU EXPERT

• My number one recommendation is to not plan anything to set in stone. Why? Because planning creates stress and pressure, whereas a boating holiday is all about providing a certain type of freedom. This freedom is stopping whenever you want, wherever you want. So take advantage of this freedom and see where your holiday takes you!

• Even if the temptation is great to go from Sarthe to Oudon or from Mayenne to Sarthe, I believe that staying on the same river throughout your stay allows you to really appreciate the place and discover unknown places, these small pearls that we only see with the slow gaze of a boating holiday..

Emilie and Raphaël, managers of the Sablé sur Sarthe and Grez Neuville bases

CHARENTE

La Charente

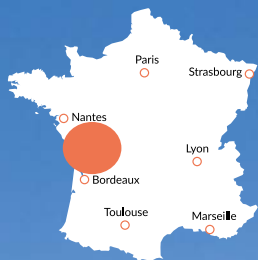

Enjoy a boating holiday on one of France's most beautiful rivers. Take in green countryside, crystal clear waters and fields of sunflowers whilst you cruise. The best bists : Locks operated by yourself so no restrictions on travel time ; Cognac and Pineau vineyards and tasting! Peaceful countryside and ancient Roman sites.



Sireuil - Nicols base

HOLIDAY HIGHLIGHTS

COGNAC: famous producers Hennessy, Martell, Baron Otard and museum of Cognac production / **JARNAC:** famous producer Courvoisier / **LES AIREAUX:** famous producers Maison Brillet and Pineau des Charentes / **SIREUIL:** the «Distillerie des Moisans» distillery.

Regional dishes such as melon charentais, mouclade, oysters and snails. The many wines of Pays Charentais.

CHÂTEAUNEUF-SUR-CHARENTE AND L'ÎLE MADAME (JARNAC): Supervised beaches, Swimming possible everywhere in the Charente river.

Trout, carp, pike, perch, eels and many more!



The Charentais vineyards



Saint-Simeux



Pineau and Charentais melon

OUR FAVORITE ROUTES

Duration	Our cruise suggestions	Km	Locks	Hours
2 Day Weekend	Sireuil > Jarnac > Sireuil	59	18	13h
1 Week	Sireuil > Saint-Savinien > Sireuil	198	30	32h

Find all our courses on the Internet or contact us.

OUR CUSTOMERS' OPINIONS



→ A family cruise - SIXTO
from 16 - 23 april 2022

A superb holiday in Charente

«We enjoyed a wonderful holiday in Charente aboard a Sixto boat which was in perfect condition. Travelling through stunning landscapes, with no time constraints due to manual locks was just as good as the amazing welcome we received from the entire Sireuil team! A big thank you to Audrey, Alex, Ludo and Ludivine.»

Julien - Vatteville-la-Rue, France

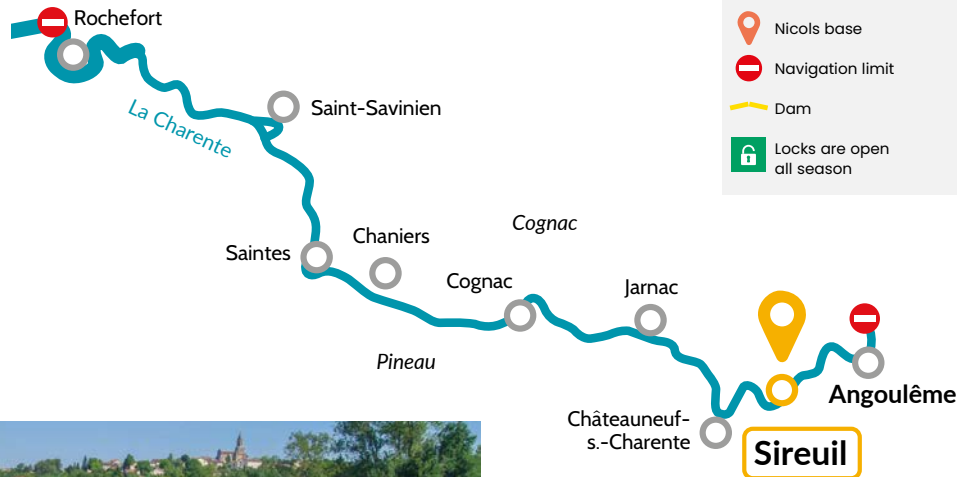

Angoulême - City of comics

THE OPINION OF OUR CHARENTE EXPERT

Three things to love about a holiday here:

- Swimming in the River Charente where the water is of excellent quality.
- Fishing, because it's always an opportunity for family fun and competition, especially if you don't catch anything!
- Embrace working together and going through a manual lock - because it's something we rarely have the opportunity to do.

All of these are perfect opportunities to take selfies and post on Instagram (with the hashtag #nicols) and make friends, family and followers jealous of your wonderful adventures!

Audrey, manager of the Sireuil base

LOT

Le Lot



The cliffs of limestone, the picturesque villages, the gastronomy: stuffed foie gras, goose confit, Cahors wine...



Saint-Cirq-Lapopie



HOLIDAY HIGHLIGHTS



SAINT-CIRQ-LAPIOIE: an interesting medieval village,
CAHORS: the Valentré bridge (a UNESCO site),
BOUZIÈS: the towpath carved into the rocks, the painted cave of Pech Merle, the 20,000 year old Castle of Cenevières.



Wines of Cahors: Château Saint-Sernin at Parnac, Le Domaine Lagarrigue at Lamagdeleine and also Le domaine Dols in Bouziès.



Regional products: truffled foie gras, goose confit, walnut cake.



Bathing in Cahors and Saint-Cirq-Lapopie Swimming is also possible in the river Lot!

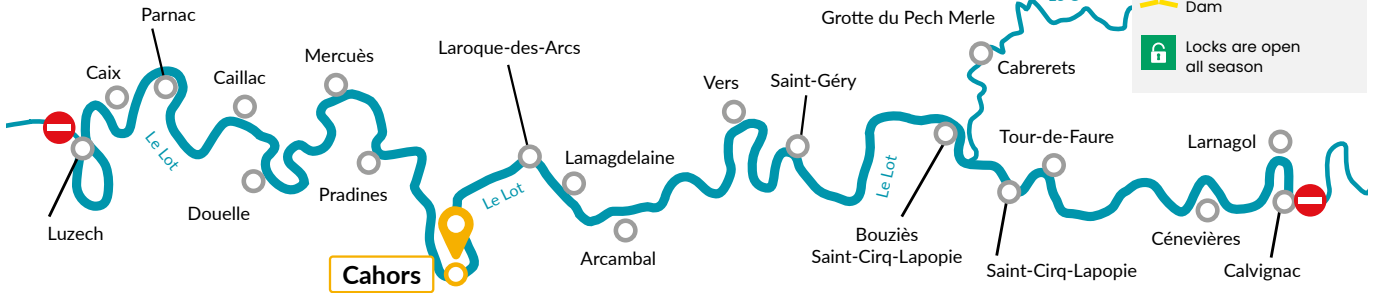

Cahors - Valentré bridge

OUR CUSTOMERS' OPINIONS



→ A family cruise - QUATTRO B
 one week from 30 July 6 August 2023

A wonderful week

«The extraordinary views we got to enjoy also returned home with us as the most beautiful holiday photos. Thank you to the Cahors team for their warm welcome and holiday advice.»

Julien - Belcodène, France



Pech Merle caves



Castle of Cénévières

OUR FAVORITE ROUTES

Duration	Our cruise suggestions	Km	Locks	Hours
Mini-Week	Cahors > St Cirq-Lapopie > Cahors	70	22	15h
1 Week	Cahors > Luzech > Larnagol > Cahors	148	34	30h

Find all our courses on the Internet or contact us.

Warning: we recommend that you've had some previous boating experience if cruising on the river Lot. Unpredictable river conditions and additional supervision mean prices for this region are slightly higher than in others: 80€ supplement per boat and per cruise.

THE OPINION OF OUR LOT EXPERT

- The River Lot is one of the most tranquil. Away from the noise and hustle and bustle of everyday life it's one of the calmest rivers and you don't need to travel far to find yourself at the "end of the world". The landscapes are constantly changing - be ready to be surprised coming out of every curve or turn.
- The best place to find yourself cut off from the world is the Isle of Dogs, between Saint-Géry and Bouziès, a place that's invisible except from the water. You have to take the dead arm on the right for about a hundred metres and there you are completely alone, not a house, not any sign of civilisation. Calm, relaxation... And that's it.

Sylvain and Alice - Cahors base

AQUITAINE

La Baïse - Le Canal de Garonne

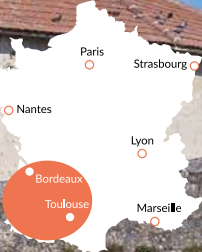

Possibility to cruise both on canal and river, automatic locks, natural beauty and cultural inheritance, local specialities : Armagnac, duck breast, Agen prunes, Buzet wines...



HOLIDAY HIGHLIGHTS



NÉRAC: Castle of King Henri IV (16th century) / **VIANNE:** fortified country house (12th century) / **FLARAN:** Cistercienne Abbey (12th century) / **CONDOM:** Cathedral and Cloister (14th century) on the pilgrimage route to Compostelle / **MOISSAC:** Abbey and Cloister (12th century) on the pilgrimage route to Compostelle / **AGEN:** canal bridge (19th century) at 530 metres long.



Wines of Buzet: Cave-Coopérative in Buzet, Château Frandat in Nérac / Armagnac: Maison Ryst-Dupeyron and the Armagnac museum in Condom Floc de Gascogne: Château de Cassaigne.



Numerous gourmet restaurants. Foie gras of duck: at the farm and duck kitchen of Lafitte à Montgaillard / Pruneau d'Agen: Roques farm in Montesquieu... / Melon de Nérac (in the markets) - The unconventional strawberry and tomato jam of Marmande (in the markets).



SWIMMING POOLS: Lud'o Parc in Nérac, Aqualand in Agen, Condom and Moncrabeau / **BEACHES:** Damazan and Fontet lakes, supervised beaches in summer.



FAMILY ATTRACTIONS: Walygator in Agen, Agrip'Aventure (tree-top assault course) in Montech, The Monkey: Indoor multi-leisure complex near Agen.

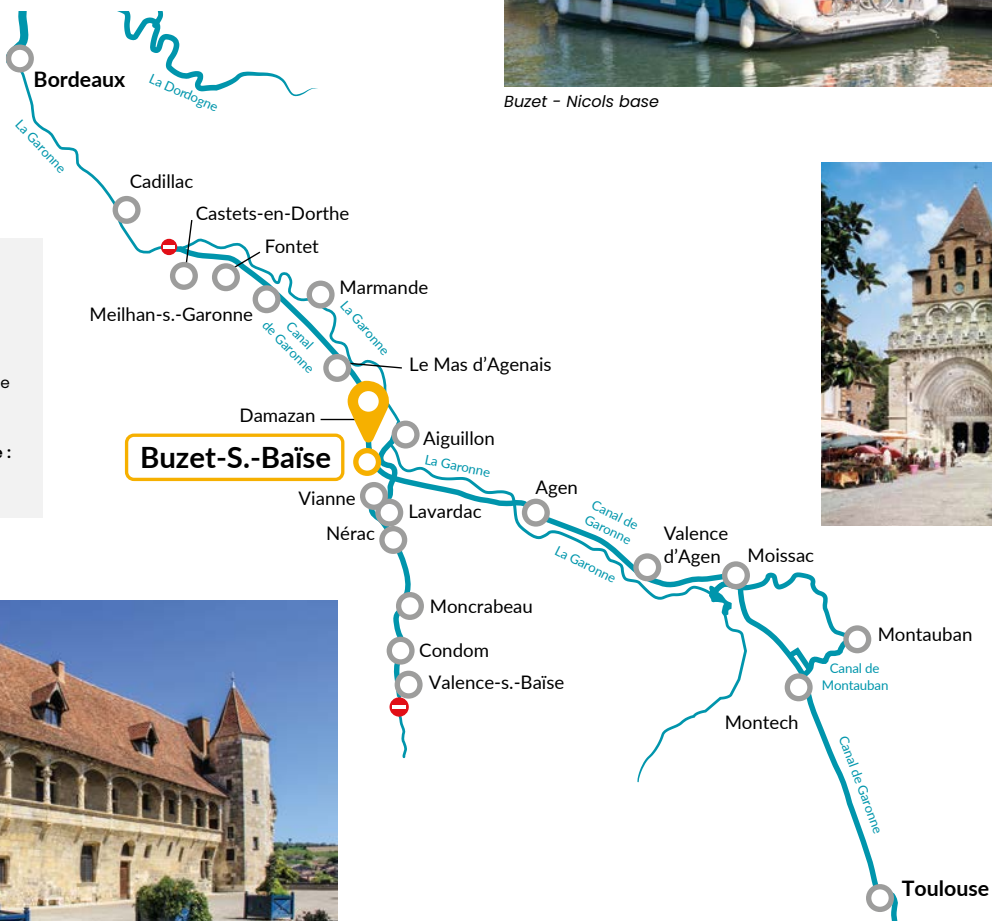

Nérac

OUR FAVORITE ROUTES

Duration	Our cruise suggestions	Km	Locks	Hours
Mini-Week	Buzet > Fontet > Buzet	98	16	17h
1 Week	Buzet > Valence / Baïse > Buzet	112	40	28h

Please note: navigation on the river Baïse may be subject to change.

Find all our courses on the Internet or contact us.

OUR CUSTOMERS' OPINIONS



➔ A family cruise - NICOLS 1010 from 12 - 14 May 2023

Happiness on the water!

«Our getaway was for four generations of women – a crew made up of grandmother, mother, daughter and granddaughters. Having recently obtained a boat licence navigating the boat was even easier than expected. The whole experience was nothing but pure happiness.»

Marina - Bayonne, France



Buzet - Nicols base



Moissac

THE OPINION OF OUR AQUITAINE EXPERT

- Come and discover a little-known region full of riches. Come to us for our heritage and our gastronomy. You can live the experience as a couple, with friends or with your family. It's a land of plenty where we live well, eat well and share well!
- Get lost (not literally) in Aquitaine which has something for everyone. It's a region of so many good things. With plenty to discover you'll want to return over and over... and for those who haven't been even the once then you are really missing out so come and see us!

Sébastien - Manager of the Buzet base / Nicole - base team member

MIDI

Canal du Midi – Canal de la Robine –
Canal du Rhône à Sète



Classified by UNESCO as a World Heritage Site, the Canal du Midi links the Atlantic with the Mediterranean and takes you through sun-drenched vineyards and to numerous villages and canal-side restaurants. The best bits: plenty of sunshine, numerous historical sites to visit, and excellent Languedoc wines from waterside vineyards.



HOLIDAY HIGHLIGHTS

WINE APPELLATIONS: Minervois, Corbières, Limoux, Coteaux du Languedoc, Saint-Chinian / **VENTENAC-EN-MINERVOIS:** wine museum / **MARSEILLAN:** cellars of Noilly Prat Numerous cellars at Marseillette, Colombiers, Puichéric, Vias and Capestang.

ADVENTURE PARKS: outdoor adventure park in Portiragnes and the indoor Europark in Vias, Tree top adventures at O2 Adventure in Carcassonne / **WILDLIFE PARKS:** Australian park in Carcassonne and African reserve of Sigean near Port la Robine.

LAKE WITH BEACH & WATERSPORTS: Etang de Jouarres near Homps / **SWIMMING POOLS:** Trèbes and Castelnaudary **BEACHES:** Vias (1 km), Port-la-Nouvelle (2 km) / Portiragnes, Port Cassafières and Agde (4 km).



OUR CUSTOMERS' OPINIONS

★★★★★ → 3-Day family weekend - SIXTO+ from 12 - 15 April 2024

A splendid weekend!

«Travelling along the Canal du Midi in Spring is very pleasant. The canal is peaceful and we really recharged our batteries in the heart of nature. The boat's engine is very quiet, which allowed us to appreciate the sound of the water and the wind».

Joséphine - Paris, France



Carcassonne

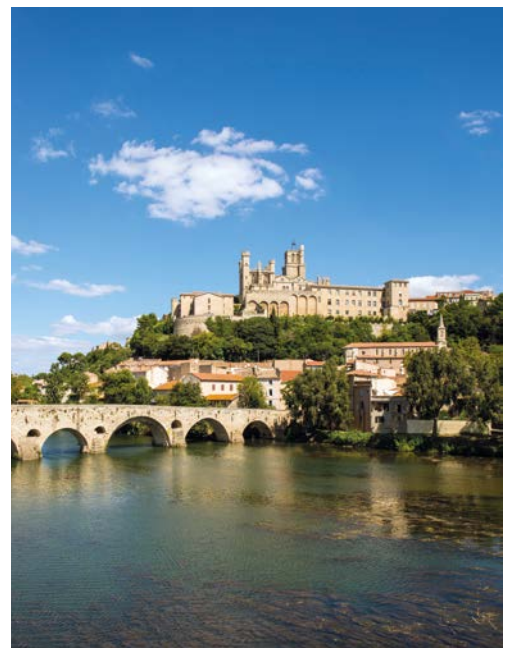

Béziers

OUR FAVORITE ROUTES

Duration	Our cruise suggestions	Km	Locks	Hours
2 Day Weekend	Le Somail > Fonsérannes > Le Somail	84	-	12h
1 Week	Le Somail > Carcassonne > Le Somail	124	54	33h
Mini-Week	Port-Lauragais > Toulouse > Port-Lauragais	90	28	22h
1 Week (One way)	Port-Lauragais > Carcassonne > Le Somail	116	60	34h

Find all our courses on the Internet or contact us.

THE OPINION OF OUR MIDI EXPERT

• My favourite thing in Autumn is to go to the Robine canal. In the evening, admire the sunset among the trees which are beginning to lose their leaves. And in the morning, feel the gentle warmth rising. It's a splendid place, far from the hustle and bustle of everyday working life.

Didier, base manager at Somail

CAMARGUE

Canal du Rhône à Sète - Étang de Thau - Canal du Midi



The Camargue's close proximity to the Mediterranean means that you will also enjoy everything that you get from a holiday by the coast. Other highlights of cruising in the region are the south of France gastronomy, getting to explore one of Europe's largest nature reserves and lock-free cruising which is perfect for boating beginners!



Aigues-Mortes Salt marshes

HOLIDAY HIGHLIGHTS

WINE APPELLATIONS: Costières de Nîmes, muscat de Frontignan, Sables wines, Picpoul and rice beer!...
GALLICIAN: wine cellar
AIGUES-MORTES: wine cellar "Les Remparts"

MEDITERRANEAN CUISINE AND LOCAL PRODUCTS: rice and salt of the Camargue, olive oils, Fougasse of Aigues-Mortes, asparagus, fish and seafood

GRAU DU ROI: Aquarium, mini golf, Babyland adventure park
AIGUES MORTES: 'Les Petits Bouts' adventure park, Train du Colorado (a 1/24 scale model railway), the 'Templar treasure hunt' around the city

Flamingos, horses and bulls of the Camargue Wildlife observation: Scamandre discovery centre, the La Marette pond near our Aigues-Mortes base!

OUR CUSTOMERS' OPINIONS



→ A week with the family – CONFORT 1100
 One way Bellegarde > Le Somail
 from 5 - 12 April 2024

An unforgettable holiday

«Family memories were made thanks to so many great discoveries and encounters during our week. We loved it so much that we've already planned a trip for next year!».

Bernard - Gruissan, France



Palavas-Les-Flots - Beach



Sète



OUR FAVORITE ROUTES

Duration	Our cruise suggestions	Km	Locks	Hours
2 Day Weekend	Bellegarde > Aigues-Mortes > Bellegarde	72	-	12h
1 Week (One way)	Bellegarde > Etang de Thau > Le Somail	174	14	31h

THE OPINION OF OUR CAMARGUE EXPERT

• If asked to name the four must see things in our region, they would be: The port of Gallician, located in the heart of the wild Camargue. Aigues-Mortes, a medieval town whose port is barely 100 metres away. The abbey of Villeneuve les Maguelonne is also a must; and the sea is never far away for those who want to swim in salt water, whether in Palavas, Carnon or Villeneuve.

Sébastien, base manager at Bellegarde

Find all our courses on the Internet or contact us.

LOIRE VALLEY / NIVERNAIS

Canal de Briare - Canal latéral à La Loire - Canal du Nivernais - L'Yonne



This is an easy to access cruising region as close to Paris (2h30). Explore numerous historical sites and enjoy internationally renowned Sancerre wines and excellent local gastronomy. There are a wide range of cruise itineraries on both canals and the river Yonne.



Local gastronomy

HOLIDAY HIGHLIGHTS



BRIARE: museum of mosaics and metals / **NEVERS:** museum of ceramics – with workshops and activities / **LA CHARITÉ-SUR-LOIRE:** a 'City of Books' and with craftsmen, calligraphers and illuminations / **GUÉDELON:** find many different types of art in the heart of the medieval castle



WINE APPELLATIONS: Sancerre, Pouilly fumé, coteaux du Giennois
POUILLY-SUR-LOIRE: wine-tourism centre
SANCERRE: Wine house with tasting sessions and shop



BEACHES: in Châtillon-sur-Loire, Nevers beach in the summer and at the Guétin canal bridge
SWIMMING POOLS: in St-Satur and in Nevers enjoy the pool on the banks of the Loire and watersports centre "Ilot Corail"



OUR FAVORITE ROUTES

Duration	Our cruise suggestions	Km	Locks	Hours
Mini-Week	Plagny > Sancerre > Plagny	112	22	25h
1 Week	Plagny > Briare > Plagny	190	32	35h

Find all our courses on the Internet or contact us.

OUR CUSTOMERS' OPINIONS



→ 1 week with friends – NICOLS 1170
 from 13–20 April 2024

Discovering the canal Latéral à la Loire

«The canal Latéral à la Loire is like turning a page through history. The route here is beautiful while the friendly at the Plagny base have plenty of holiday tips and excellent advice to set you up for an enjoyable adventure».

Armand – Aspach Michelbach, France



La Charité-sur-Loire



Nevers – Ducal Palace



Bec D'allier

THE OPINION OF OUR LOIRE VALLEY / NIVERNAIS EXPERT

• Our three waterways, Canal Lateral à la Loire, Canal de Briare and Canal du Nivernais, are all easy to navigate. Regular boaters will be surprised to discover that on these waterways, the advantage is being able to moor wherever they want, either on pontoons or simply in the countryside. My advice for a successful cruise: throughout the navigation, you have to go slowly and keep your eyes open as only children know how to do. A beautiful flower, a surprising tree or even a pile of stones can reveal unsuspected treasures that it would be a shame to miss.

Florent, base manager in Plagny

BURGUNDY

Canal de Bourgogne - Canal du Nivernais - L'Yonne



Close to Paris (or 2 hours by car), discover the Canal de Bourgogne - one of the best known canals in France - which winds its way through beautiful Burgundy countryside. Do not forget to discover the richness of its cultural heritage, its world famous wines and cuisine to try!

HOLIDAY HIGHLIGHTS



VENAREY: Alésia Museopark
MONTBARD: Fontenay Abbey (UNESCO site)
BUFFON: large forges monument in Buffon
ANCY LE FRANC ET TANLAY: renaissance castles
TONNERRE: Hôtel Dieu and Fosse Dionne
AUXERRE: clock tower, Saint-Germain Abbey and Saint-Etienne cathedral



WINE APPELLATIONS: Chablis, Auxerrois, Tonnerrois, Crémant de Bourgogne / **FLAVIGNY-SUR-OZERAIN:** domaine Flavigny-Alésia / **TONNERRE:** wine cellar visit, tastings and excursions organised by winegrowers / **CHABLIS:** Bérus wine estate **SAINT-BRIS-LE-VINEUX:** Bailly-Lapierre wine cellars



GOLF: At Tanlay Castle (9-hole course) and at Venarey (7-hole course)



Delicious local foods



Alise-Sainte-Reine Museoparc in Alésia

OUR FAVORITE ROUTES

Duration	Our cruise suggestions	Km	Locks	Hours
Mini-Week	Venarey > Ancy-le-Franc > Venarey	82	50	21h
1 Week	Venarey > Tanlay > Venarey	124	68	31h

Find all our courses on the Internet or contact us.

OUR CUSTOMERS' OPINIONS



→ A week with the family – QUATTRO B from 13 – 20 Avril 2024

Our holiday memories:

«A total disconnection, friendly encounters with the lock keepers and sharing the passing of locks with other boats and their crews...which we're sure is the case for boating holidays in other destinations too».

Laurence – Saint-Laurent de Mûre, France



Ancy-le-Franc



Nicols base
 Locks closed on 1st May

Venarey-laumes



Fontenay Abbey

THE OPINION OF OUR BURGUNDY EXPERT

• The Canal de Bourgogne is a good destination for a very first boating holiday. Navigation is easy. And if you're searching for peace and quiet, this is the ideal place: you can plant your stakes and moor in the countryside. Everything here is green and hilly. In summary, in Venarey...nNature awaits you!

Stéphane, base manager at Venarey

FRANCHE-COMTÉ / SAÔNE

La Saône - Canal du Rhône au Rhin - Canal de Bourgogne - Canal des Vosges



A crossroads of rivers that offer an excellent choice of cruises: the deep valley of the Doubs, the naturally charming Saône, with few locks, a fishing paradise! For the gourmets, cheese and fine Franche-Comté wines.



Osselle caves

ALSACE

Canal de la Marne au Rhin - Canal de la Sarre - La Moselle

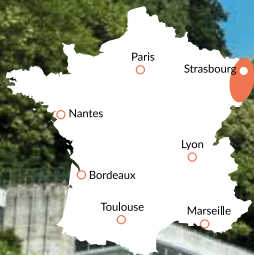

Enjoy a French boating holiday in the Alsace, a region full of history and fantastic gastronomy. The best bits: magnificent scenery – mountains and forests frame your route ; delicious regional food and wines; watersports, cycling and hiking – something for everyone! Wonderful art and architecture in the cities...



OUR CUSTOMERS' OPINIONS



→ 1 week with the family – CONFORT 1350 B
from 7 – 14 April 2022

Discover, meet, relax!

«Navigating was easy and great fun while we enjoyed friendly encounters with other boaters at the ports. Our youngest crew members loved the visit to Lutzelbourg and the restaurant at Saverne was great.»

Elie – Hampteau (Hotton), Belgique



Saverne

HOLIDAY HIGHLIGHTS



LÜTZELBOURG: crystal works
INCLINED PLANE: glass blower workshops and crystal works
SARREGUEMINES: ceramics production



SAVERNE: castle of Rohan, castle of Haut-Barr
ARZVILLER: the inclined plane, unique in France
SARREBOURG: stained glass chapel window by Chagall
NANCY: Place Stanislas square, Palace of the Dukes



Zoo and fauna park at Sainte-Croix and "Nature de Cheval" equestrian centre in Altwiller, alpine luge rides at the Arzviller incline Waterparks in Saverne (Océanide) and Hochfelden (Atoo), beach and water based activities in Mittersheim



GOLFS: 18-hole courses in Nancy and Sarreguemines, 27-hole course in Strasbourg



Strasbourg - La Petite France

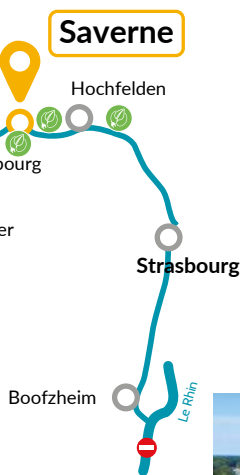

- Nicols base
- Navigation limit
- Licence necessary
- Charging terminals
- Locks closed on 1st May



Mittersheim

OUR FAVORITE ROUTES

Duration	Our cruise suggestions	Km	Locks	Hours
Mini-Week	Saverne > Strasbourg > Saverne	92	40	22h
1 Week	Saverne > Mittersheim > Saverne	122	50	32h

Find all our courses on the Internet or contact us.

◀ Arzviller – Inclined Plane

THE OPINION OF OUR ALSACE EXPERT

• I'll share a secret corner...Just near the large Réchicourt lock, on the right side, there is an old lock ladder. Turn in its direction, slowly so that no one follows you and so as not to scare the birds. You will arrive at a very nice little secluded corner that's the perfect picturesque and peaceful setting. You can moor in the wild, have a barbecue and spend a night lulled by the sound of the water and awakened by the song of the birds.

Cédric, Saverne base manager

GERMANY

MECKLEMBURG & MÜRITZ



Explore green countryside and beautiful waterways! A quiet region with numerous cruises across lakes surrounded by rich flora and fauna.



HOLIDAY HIGHLIGHTS



PLAU: castle with tower
SCHWERIN: castle with gardens, 18th century market square, half-timbered and gabled houses from the end of the 17th century
MALCHOW: town mill



MÜRITZ NATIONAL PARK: 322 km² of forests, lakes and marshes and the largest lake in Germany with more than 150 species of birds. **WAREN:** Müritzeum aquarium
BÄRENWALD MÜRITZ: a bear protection scheme in the forest



Swimming in the clear waters of the lake!



Mirow



For non-licence holders Extra 3 hours of instruction required at a cost of 75€ to be paid locally.



Regional specialty: smoked fish

OUR FAVORITE ROUTES

Duration	Our cruise suggestions	Km	Locks	Hours
3 Day Weekend	Lütz > Jabel > Lütz	84	8	8h30
1 Week	Lütz > Schwerin > Lütz	144	8	26h

Find all our courses on the Internet or contact us.

◀ Müritznaher See

OUR CUSTOMERS' OPINIONS



➔ A week with the family – NICOLS 1010 from 11 – 18 August 2023

A wonderful holiday!

«The stunning lakes, the pleasant weather, the pretty towns on route, the passage (a little tricky at first) of the locks... We have wonderful memories of our boating adventure in Germany!»

David - Vaucresson, France



Schwerin



THE OPINION OF OUR GERMANY EXPERT

- Schwerin is a beautiful city with a dream castle. The castle is the seat of government of Mecklenburg. Every day, a guided tour is organized at 11:30am...the price is very reasonable and the visit is worth it!
- Plau am See is a small town located directly on the shores of Lake Plau. It's a pretty little old town, ideal for strolling, eating and drinking coffee.
- Finally Malchow which is an island town located between Plau am See and Waren. Its location is ideal and its old centre is definitely worth the detour.

Isabelle, manager of the Lütz base

HOLLAND

Maas - Merwedekanaal - Vecht - Gouwe



Famous for windmills, cheese, tulips and of course canals, the Netherlands is the perfect destination for enjoying a boating holiday! Captain a Nicols boat and discover picturesque towns and villages, art and history museums and the stunning Natura 2000 listed national park. Natural waters are great for swimming and of course bikes on board mean that you can enjoy the national pastime of cycling!



HOLIDAY HIGHLIGHTS



Biesboch National Park, a Natura 2000 listed area
Numerous nature reserves: Maasbommel, Mook-Plasmolen, Leukermeer



GOUDA: Sint-Jans church, charming city streets
AMSTERDAM: art museums (Van Gogh Museum), history and science museums, Red Light District, house of Anne Frank
WOUDRICHEM: medieval castle of Loevestein (14th century)
HEUSDEN: fortified city.



SPECIALITIES: Gouda cheese from Gouda!
The 'Bossche bowl': a profiterole type pastry from the Dutch city of 's-Hertogenbosch
'Stroopwafels': caramel filled waffles and bacon - Many Dutch beers!



The popularity of bikes here means there are many cycle routes to be enjoyed.



Gouda, Traditional cheese market



1 hour of navigation instruction required at a cost of 50 € and to be paid at the time.

OUR FAVORITE ROUTES

Duration	Our cruise suggestions	Km	Locks	Hours
2 Day Weekend	Kerkdriel > Heusden > 'S-Hertogenbosch > Kerkdriel	65	2	8h30
1 Week (One way)	Kerkdriel > Gouda > Amsterdam > Utrecht > Usselstein > Montfoort	244	8	25h30

Find all our courses on the Internet or contact us.

THE OPINION OF OUR HOLLAND EXPERT

Share with us their top three places to add to your holiday itinerary.

- The fortified town of Heusden on the Meuse.
- The 'Keukenhof' tulip festival (mid-March - mid-May).
- Biesboch National Park (Nature Reserve).

Gina and Dico, managers of the Kerkdriel

OUR CUSTOMERS' OPINIONS



➔ Short break for a couple, - Estivale DUO from 23-27 April 2024

Super experience!

«We received such a warm welcome in Kerkdriel. The Gorinchem town port was great to visit and life on board the boat was a wonderful experience»

Thomas - Solingen, Allemagne



Heusden fortified city

MONTFOORT :

In the Netherlands, the fleet is available from KERKDRIEL. From June to mid-September, cruises can also be organised to or from the secondary base in Montfoort. Cruises with departure and/or arrival in Montfoort are subject to a surcharge of €200.

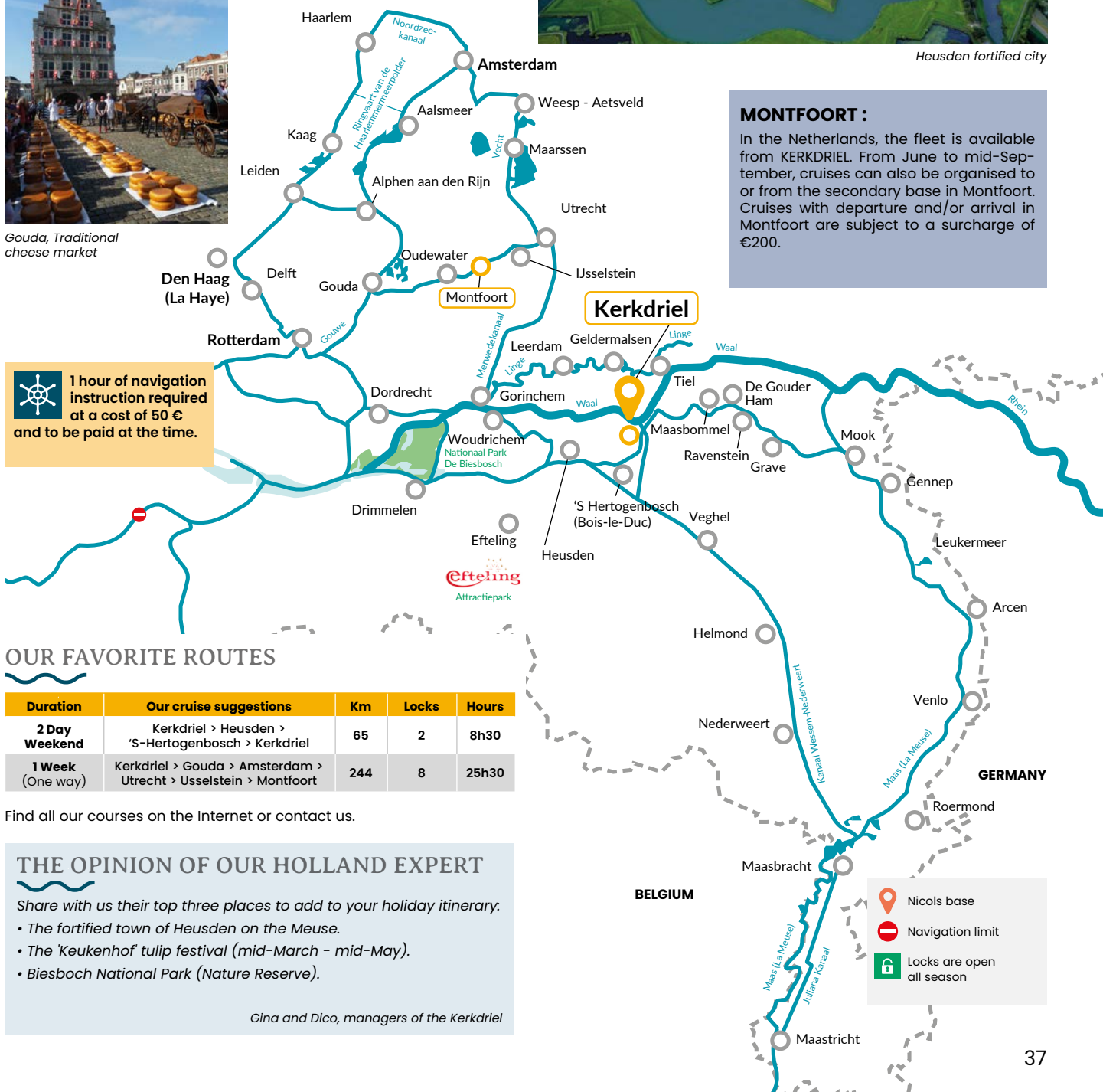

BELGIUM

GERMANY

- Nicols base
- Navigation limit
- Locks are open all season

IRELAND

Shannon-Erne



Beautiful nature surrounds the Shannon River which at 220km is the longest river in the British Isles. It is also a paradise for fishermen and is perfect for those new to boating holidays as there is no commercial traffic on the waterways and only a few locks to negotiate. Picturesque little villages dotted along the waterways invite you to slow down and explore this wonderful region.

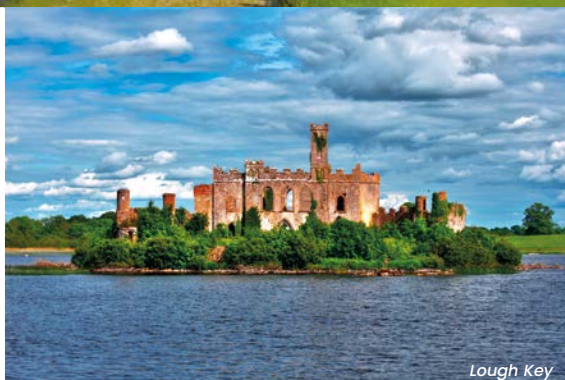

Lough Key

HOLIDAY HIGHLIGHTS



ENNISKILLEN : 15th century castle
CLONMACNOISE : 6th century monastery
ATHLONE : Church of St. Peter and St. Paul - 20th century
PORTUMNA : 17th century Renaissance castle



ATHLONE
BOYLE
ENNISKILLEN



LOUGH* KEY Forest & Activity Park
LOUGH* DERG (note Lough is the Irish name for a lake/loch)



Republic of Ireland: no fishing permit is needed for angling on the Shannon River (except for salmon and trout fishing).
Northern Ireland: a fishing permit is required for all types of angling.



- Base Nicols
- Navigation limit
- Locks are open all season

Please note: Departing from Bellanaleck will involve you navigating on vast lakes. The distances you are able to travel during your boating holiday may therefore vary depending on the route/itinerary chosen.

OUR CUSTOMERS' OPINIONS



→ A week with the family – Estivale SIXTO from 15 – 22 June 2023

A fantastic week !

«I had a fantastic week aboard the Sixto. There were 5 in our group + 2 dogs. The boat is very spacious, comfortable and very generous for storage yet doesn't feel overly big to drive. We travelled from Lough Key to Athlone. Weather was good, scenery spectacular. A holiday to remember! Thanks to the Carrick-on-Shannon team.»

William & Lydia



Clonmacnoise



Irish Pub



OUR FAVORITE ROUTES

Duration	Our cruise suggestions	Km	Locks	Hours
Mini-Week	(Erne) Bellanaleck > Belleek > Crom Castle > Bellanaleck	-	-	16h
1 Week	(Erne) Bellanaleck > Enniskillen > Belleek > Ballyconnell > Bellanaleck	-	-	20h
1 Week	(Shannon) Carrick > Athlone > Carrick	176	6	22h
1 Week (One way)	(Shannon) Carrick > Banagher	140	6	20h

Find all our courses on the Internet or contact us.

THE OPINION OF OUR IRELAND EXPERT

• Ireland is well known for the kindness of its people and you will always be warmly welcomed wherever you go. There is breathtaking scenery around every corner and a relaxed, laid back attitude to life. There is also plenty to do along the waterways, whether you are interested in history and heritage, fishing, walking or even golf.

Andrew et Wendy, managers of the Ireland base

HUNGARY

Bodrog - Tisza



Set sail on the rural rivers of Hungary! Nicols have two departure bases to choose from - Kisköre in the south sailing between lakes and national parks or Tokaj in the north and in the heart of a world-famous wine region.



HOLIDAY HIGHLIGHTS



Historical vineyard of the Tokaj-Hegyalja region (World Heritage Site since 2002), Bodrogkeresztúr, Sárospatak, Herceggút and Sátoraljaújhely vineyards



Swimming possibilities in Kisköre, Abádszalók, Tiszafüred, Sarud and Poroszló. Swimming in safe and clean rivers.



Hortobágy National Park - La Puszta grassland (UNESCO World Heritage Site), Bodrogzug-Tokaj Protected Park, Ecocentre and the giant aquarium at Poroszló



TOKAJ: its UNESCO heritage listed wineries, **SÁROSPATAK:** castle (15th - 16th century), **TISZADOB:** Andrassy castle, **SZABOLCS:** church (11th century)



Tokaj - vineyard

OUR CUSTOMERS' OPINIONS



→ A week with friends - QUATTRO B from 18 - 25 July 2020

A la découverte de la Hongrie

«We boarded a Quattro B from the small town of Tokaj, known for its internationally renowned wines. The region is magnificent and presents a landscape dotted with vineyards, valleys and small mountain ranges.»

Gerhard - Graz, Autriche



Typical Tokaj cellars



Tiszadob - Andrassy Castle



Sarud

OUR FAVORITE ROUTES

Duration	Our cruise suggestions	Km	Locks	Hours
2 Day Weekend	Kisköre > Tiszafüred > Kisköre	60	0	8h
1 Week (One way)	Kisköre > Tokaj	256	1	31h00
2 Day Weekend	Tokaj > Sárospatak > Tokaj	74	0	9h
1 Week	Tokaj > Sátoraljaújhely > Dombrád > Tokaj	250	0	31h

Find all our courses on the Internet or contact us.

THE OPINION OF OUR HUNGARY EXPERT

• If you choose Lake Tisza, you can spend your holiday in wonderful natural surroundings. You can get away from the world or if you want to have an exciting adventure, a gastronomic experience or just go to the beach, you can choose a stop off at one of the many marinas. What's more, from our base in Tokaj, you can taste the world-famous Tokaj wines on site.

Lajos - Base team member at Kisköre

PORTUGAL

Lago Alqueva



Enjoy plenty of sunshine and swimming and watersports in clean warm waters. Anglers can fish for black bass, carp and more. Numerous activities await such as cycling, quad bike riding or for a slower pace of life why not discover the richness of fauna and flora, or historical interests such as fortified villages, archaeological sites and locally produced traditional handicrafts and pottery. Taste regional traditional cooking and a meal with a view at the panoramic restaurant on the port.



Lago Alqueva

HOLIDAY HIGHLIGHTS



MOURÃO: castle and fortifications (13th century)
MONSARAZ: fortified city
LUZ: rebuilt village after flooding and museum



Swimming and diving in the clean waters of the lake, watersports, shaded and supervised beaches in Amieira, Mourão, Monsaraz, Alqueva and Miralago.



Black bass, pikeperch, pike, barbed comizo
 Lure fishing and rock fishing

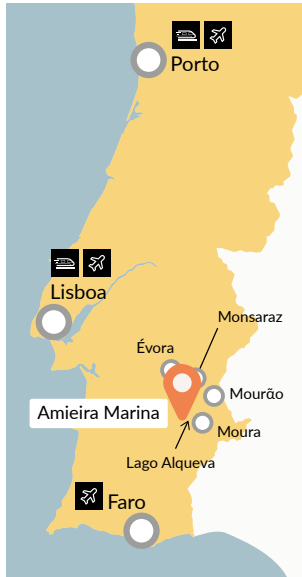

For car rental advice from Lisbon or Faro airports please contact us for more details.

Juromenha

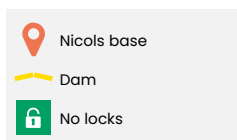

Alandroal typical village

Temperatures at lake alqueva

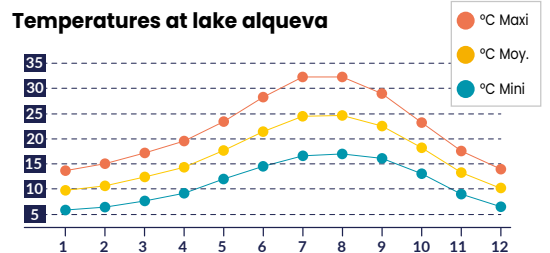

OUR FAVORITE ROUTES

Duration	Our cruise suggestions	Km	Locks	Hours
Mini Week	Amieira > Monsaraz > Amieira	163	0	18h
1 Week	Amieira > Juromenha > Amieira	278	1	30h

Find all our courses on the Internet or contact us.

All our boats are equipped with 1 quay plug 220 Volts, electric toilet, sounders, GPS, monitor / DVD, solar panels. For rent at the base: bikes, canoes, kayaks...

OUR CUSTOMERS' OPINIONS



→ 4 days - Estivale DUO
 1 adult and 1 teenager aged 16

Super experience!

«We loved the experience of mooring the boat in the middle of the lake, attached to a buoy. We were able to swim from the boat in the middle of the lake. Is there anything more fun for a teenager than jumping off the boat into the water when it's 33°C?»

Guido - Clisson, France

THE OPINION OF OUR PORTUGAL EXPERT

If he had to recommend just three things to do during your boating holiday in Portugal then they would be:

- Go stargazing at Campinho (site classified as a "Starlight destination")
- Visit the Luz museum, telling the story of the village of Luz which was swallowed up by the waters of the Grande Lago after the construction of the Alqueva dam, and then rebuilt on the banks of the lake.
- And, a new and surprising experience, go to the Golden Island in Monsaraz to take a mud bath!

Tiago, from the Amieira base

THE NICOLS FLEET

The key to a successful boating holiday is in choosing the best boat from our five different ranges: Fly, Estivale, Confort, Sedan or Riviera. The following information will help you make your selection of boat before reading full details boat by boat over the next pages (pages 44 to 58).



MAKE YOUR CHOICE - THERE'S A BOAT FOR YOU!



Read our detailed boat descriptions.

Example: a boat described as being a 4/6 is a boat which offers spaces for 4 people in cabins + 2 extra spaces in the converted living-room area.

Comfort and equipment















COMFORT:

Use our simple 1 to 5 scoring system to easily identify the comfort levels of each boat type.

EQUIPMENTS:

A key to the main equipment found on board a Nicols boat:

	Heating		Sun awning sliding / Sun awning		TV with satellite channels		Dishwasher
	Microwave		Air conditioning		Electric toilets		DVD monitor
	Stem propeller		Air conditioning from shore power		Double steering position		Electrical connector 220 V on board

HOME-FROM-HOME COMFORT



Our boats have a vast living room with a **360° panoramic view**. The kitchen includes lots of equipment and has everything you'll need: **220l fridge with a freezer compartment***, ring-hob, oven / grill depending on boat model * and wide work top areas. The kitchenware is supplied as well as the bedding (sheets, duvets, pillows). Terraces are equipped with garden furniture and either a sun awning or parasol depending on the boat model.

**Fridge 220l except on: Riviera range, N800 and Primo. Oven: except N800.*

A quarter of the Nicols fleet is equipped with air-conditioning systems, providing perfect onboard temperatures - even in summer.

YOUR SAFETY ASSURED

To make moving from one end of the boat to the other safe and easy all our walkways are covered with an antislipping surface, have a hand rail and a double railing* at a height of 60 cm (safety criteria imposed by the legislation for boats made in France).

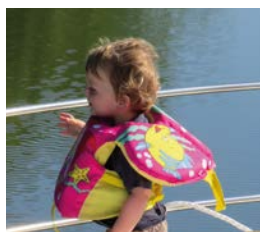

The rear terrace on the Sedan, Estivale and Fly range are on the same level as the living room meaning there are no stairs to negotiate going either in or out of the boat. The front terrace of the Confort range can be reached via a gangway 1 metre high moulded into the hull deck for the maximum safety. All these criteria mean that **Nicols boats are one of the safest on the market**, particularly when it comes to **accommodating crews with children and/or people with reduced mobility**.

**Except N800 and Primo*



FLY RANGE

The Fly range – Nicols biggest and best boat yet!



OctoFly C

KEY FACTS

- Upper deck with plancha / breakfast area
- Sun awning and deck mattress
- Covered rear terrace
- Private bathroom for each cabin



Alfresco dining area

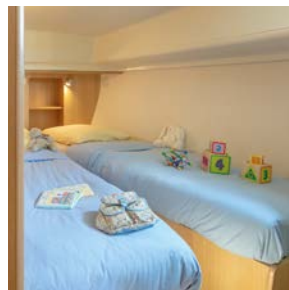

Cabin



Awning & mattress

THE FLY RANGE is the latest series from the nicols boatyard. its models, ranging from 12.95m to 14.95m long, are some of the easiest boats to steer thanks to their double bow thruster (stern and bow).

We're confident that our boats in the Fly range offer the best accommodation available anywhere in the boating holidays market. They come fully-equipped with: large fridge, hob and oven, television with satellite antenna, radio / CD / MP3, 220 V shore power connection, our 'C' boat models even have an on board generator for using 220 V power during navigation and **air-conditioning**, which provides extra comfort in the summer months!

The boats have a covered rear terrace with outdoor dining furniture and access to the upper deck area which has a breakfast area + outdoor kitchen (sink, plancha grill) under the shade of a bimini awning, a second outdoor steering position and a deck area for two mattresses – the perfect space for lazing in the sun.

So what are you waiting for? Be the envy of the others on the waterways and travel in style and comfort – no previous boating experience or licence is needed.





Upper deck with deck mattress



Upper deck with plancha / breakfast area



Living area and fully-equipped kitchen



Covered rear terrace

	Quattro® Fly C Quattro® Fly C GREEN	Sixto® Fly C	Octo® Fly	Octo® Fly C	Octo® Fly 12
Maximum capacity	6 people	8 people	10 people	12 people	
Capacity recommended	6 adults	4 adults	8 adults	8 adults	8 adults / 2 childds
Length / Width	12,95 x 3,85 m	14,95 x 3,85 m	14,95 x 3,85 m		
ROOM LAYOUT					
Cabins	2 + saloon	3 + saloon	4 + saloon		
Double-beds (140 x 190 cm)	2 + saloon	2 + saloon	4 + saloon		
Double-beds (160 x 200 cm)	-	1	-		
Single-bed (70 x 190 cm)	4 possible	4 possible	8 possible		10 possible
Bathroom / electric toilets	2	3	4		2
Saloon	11 m ²	11 m ²	11 m ²		
KITCHEN EQUIPMENT					
200 L fridge (freezer)	●	●	●	●	●
4 ring-hob	●	●	●	●	●
Oven	●	●	●	●	●
Dishwasher	●	●	-	●	-
Microwave	●	●	●	●	●
« Senseo » electric coffee maker	●	●	●	●	●
OTHER INTERIOR EQUIPMENT					
Air conditioning	●	●	-	●	-
Heating	●	●	●	●	●
Radio, CD, MP3	●	●	●	●	●
DVD monitor	●	●	●	●	-
TV with satellite channels	●	●	●	●	Smart TV
Safe	●	●	●	●	●
Electrical connector 220 V on board	●	●	●	●	●
OTHER EXTERIOR EQUIPMENT					
Garden furniture	●	●	●	●	●
Sun awning sliding	●	●	●	●	●
Sun awning	●	●	●	●	●
Bathing ladder	●	●	●	●	●
Shower	●	●	●	●	●
Gas griddle/BBQ	●	●	●	●	●
Sunbathing	●	●	●	●	●
Double steering position	●	●	●	●	●
Double bow thruster (stern and bow)	●	●	●	●	●
Water tank capacity	600 L	1050 L	1050 L	1050 L	1050 L
Fuel tank capacity	375 L (Fly C)	375 L	375 L	375 L	375 L
Electric powered	Fly C Green	-	-	-	-

All photos and descriptions are non-contractual. We reserve the right to modify them without prior notice.

4/6

Quattro Fly C / Fly C Green



Recommended for 2 couples or 1 couple with 2 children

- 2 cabins + convertible living room
- 2 showers / 2 electric toilets
- On the fly: Alfresco dining area / outdoor kitchen



Just like the Sixto® Green, the Quattro Fly C Green is a completely silent, "zero emission" rated, non-polluting and environmentally-friendly electric powered canal boat!

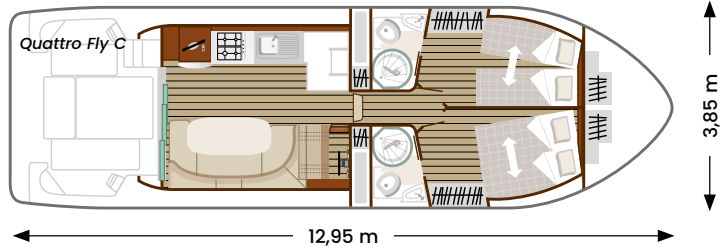

6/8

Sixto Fly C



Recommended for 3 couples or 2 couples with 2 children

- 3 cabins + convertible living room
- 3 showers / 3 electric toilets
- On the fly: Alfresco dining area / outdoor kitchen

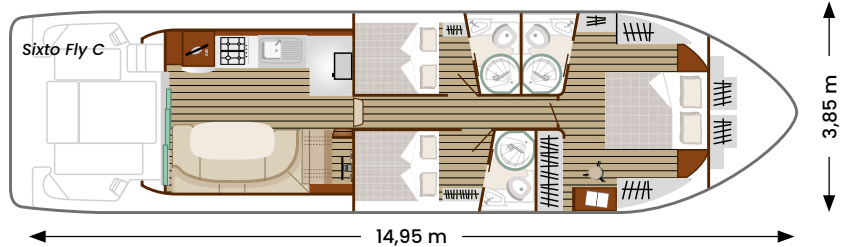

8/10

Octo Fly



Octo Fly C



Recommended for 4 couples or 2 couples with 4 children

- 4 cabins + convertible living room
- 4 showers / 4 electric toilets
- On the fly: Alfresco dining area / outdoor kitchen

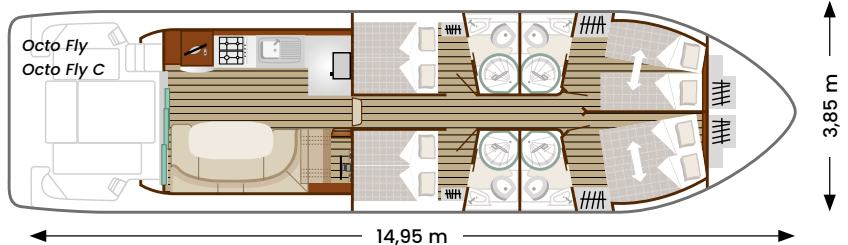

10/12

Octo Fly 12



Recommended for 4 couples or 2 couples with 4 children

- 4 cabins + convertible living room
- 2 showers / 2 electric toilets
- On the fly: Alfresco dining area / outdoor kitchen

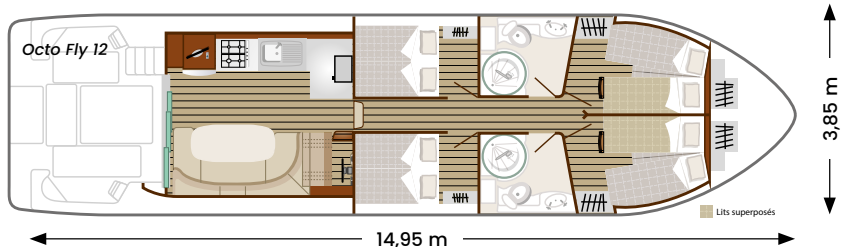

Full details on page 47

ESTIVALE RANGE



Quattro

KEY FACTS

- The very best facilities and equipment
- Two steering positions
- Beautiful living space - living room and terrace
- Boarding via rear and side doors.
- 2-10 people



Double steering position



Rear terrace



Kitchen Sixto Prestige / C

	Duo	Quattro Quattro B / B+	Quattro S	Sixto Prestige C	Sixto Sixto + Sixto Green	Octo
Maximum capacity	4 people	6 people		4 people	8 people	10 people
Capacity recommended	2 adults	4 adults		4 adults	6 adults	8 adults
Length / Width	8,85 x 3,40 m	10,85 x 3,80 m			13,50 x 3,80 m	
ROOM LAYOUT						
Cabins	1 + saloon	2 + saloon		2 + saloon	3 + saloon	4 + saloon
Double-beds (140 x 190 cm)	1 + 1 saloon	2 + 1 saloon		1 + 1 saloon	3 + 1 saloon	4 + 1 saloon
Double-beds (160 x 200 cm)	-	-		1	-	-
Single-bed (70 x 190 cm)	-	4 possible	2	2 possible	2 possible	8 possible
Bathroom / electric toilets	1	2	1	2	2 (3 Sixto +)	2
Saloon	8 m ²	9 m ²		11 m ²	11 m ²	11 m ²
KITCHEN EQUIPMENT						
220 L fridge (freezer)	●	●	●	(195 L)	●	●
4 ring-hob	(2 ring-hob)	●	●	●	●	●
Oven	(Grill)	●	●	●	●	●
Dishwasher	-	-	-	●	-	-
Microwave	-	-	-	●	-	-
« Senseo » electric coffee maker	-	-	-	●	-	-
OTHER INTERIOR EQUIPMENT						
Air conditioning	-	-	-	●	-	-
Air conditioning from shore power	-	(Quattro B+)	●	-	(Sixto +)	-
Heating	●	●	●	●	●	●
Radio, CD, MP3	●	●	●	●	●	●
DVD monitor	●	●	●	●	●	●
TV with satellite channels	-	-	-	(1 saloon + 1 cabin)	-	-
Safe	-	-	-	●	-	-
Electrical connector 220 V on board	●	●	●	●	●	●
OTHER EXTERIOR EQUIPMENT						
Garden furniture	●	●	●	●	●	●
Sun awning sliding	●	●	●	●	●	●
Sun awning	-	(Quattro B+)	●	●	(Sixto +)	-
Bathing ladder	●	●	●	●	●	●
Shower	●	●	●	●	●	●
Double steering position	●	●	●	●	●	●
Stem propeller	-	(Quattro B / B+)	●	●	●	●
Water tank capacity	750 L	750 L	750 L	1050 L	1150 L	1150 L
Fuel tank capacity	270 L	270 L	270 L	270 L	270 L	270 L
Electric powered	-	-	-	-	Sixto Green	-

All photos and descriptions are non-contractual. We reserve the right to modify them without prior notice.

2/4 Comfort and equipment

Duo



Recommended for 2 adults

- 1 cabin + convertible living room
- 1 shower / 1 electric toilets

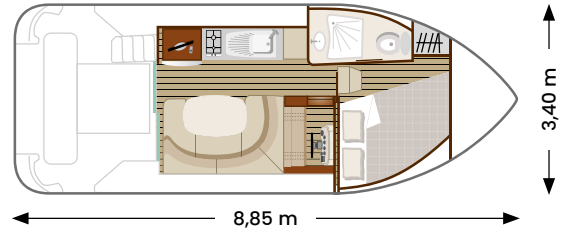

4/6 Comfort and equipment

Quattro



4/6 Comfort and equipment

Quattro B



4/6 Comfort and equipment

Quattro B+



Recommended for 2 couples or 1 couple and 2 children

- 2 cabins + convertible living room
- 2 showers / 2 electric toilets

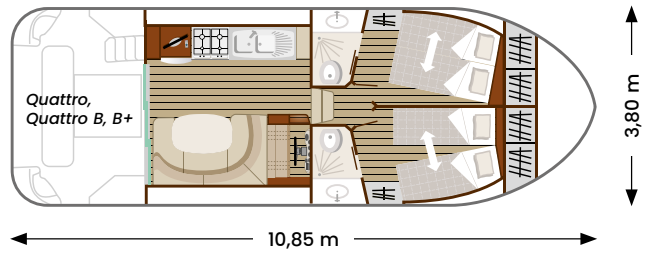

4/6 Comfort and equipment

Quattro S



Recommended for 2 couples or 1 couple and 2 children

- 2 cabins + convertible living room
- 1 shower / 1 electric toilets

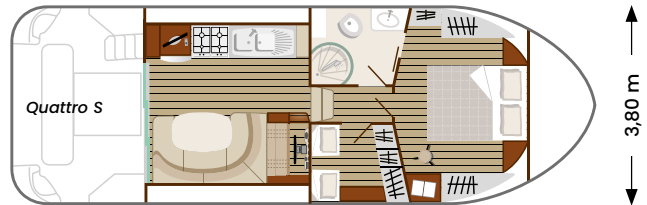

4/6 Comfort and equipment

Sixto Prestige C



Recommended for 2 couples or 1 couple and 2 children

- 2 cabins + convertible living room
- 1 dressing
- 2 showers / 2 electric toilets

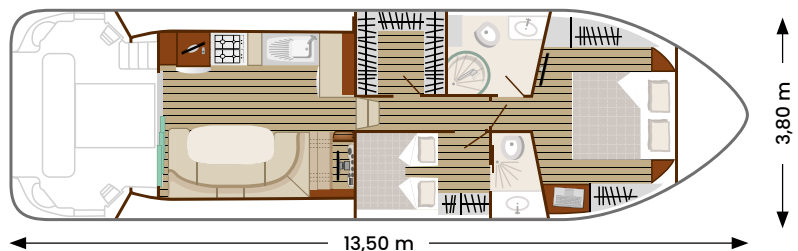

Full details on page 49

6/8 Comfort and equipment

Sixto Green



Nicols is proud to have been **the first boat builder and holiday operator in Europe** to launch **a 100% electric powered canal boat**. With **a totally silent engine and zero emissions** the Sixto* Green is non-polluting and environmentally friendly*.

Recommended for 3 couples or 2 couples with 2 children

- 3 cabins + convertible living room
- 2 showers / 2 electric toilets



VNF Charging Terminal**

**VNF charging terminals and their moorings are reserved exclusively for electric boats.

*100% of the electricity supplied by EDF on the charging terminals is guaranteed to be renewable (source VNF).

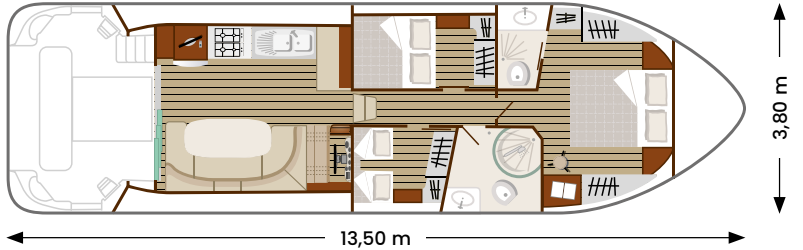

Lithium batteries on board are fast to charge with **only two hours charging time needed** to provide a cruising range of **between six to eight hours**, so enough for between a day and a day and a half of navigation. VNF's fast charging terminals are located all along the waterways at approximately **every 11km** which mean you can stop wherever you want whenever you want.

NB: Available cruise information is available on page 33 (Alsace region).

6/8 Comfort and equipment

Sixto



Recommended for 3 couples or 2 couples with 2 children

- 3 cabins + convertible living room
- 2 showers / 2 electric toilets

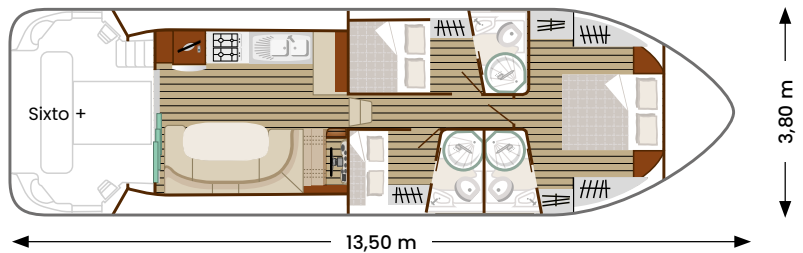
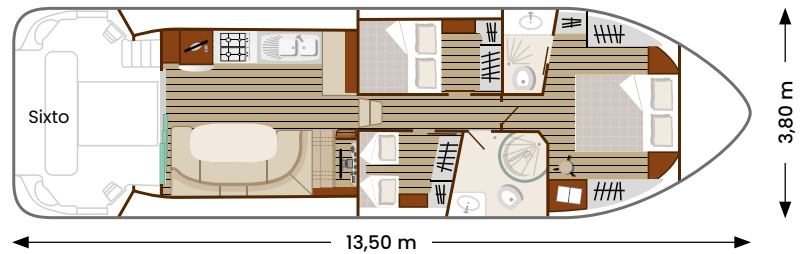

6/8 Comfort and equipment

Sixto +



Recommended for 3 couples

- 3 cabins + convertible living room
- 3 showers / 3 electric toilets

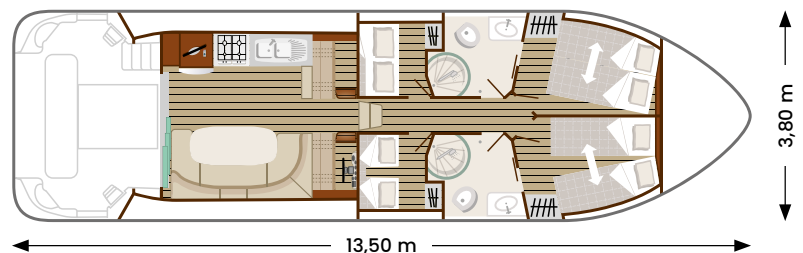

8/10 Comfort and equipment

Octo



Recommended for 4 couples or 2 couples with 4 children

- 4 cabins + convertible living room
- 2 showers / 2 electric toilets

Full details on page 49

CONFORT RANGE

CONFORT 1350 - 4/6

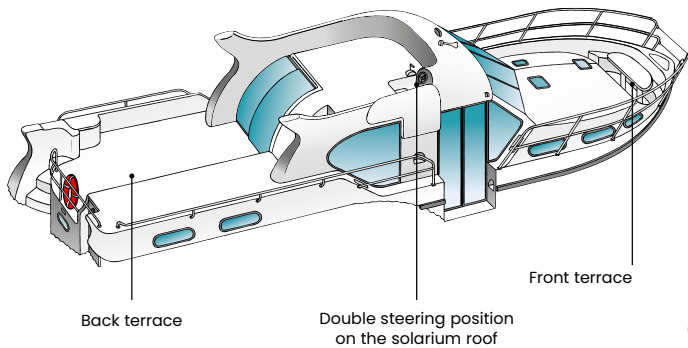

Back terrace

Double steering position on the solarium roof

Front terrace

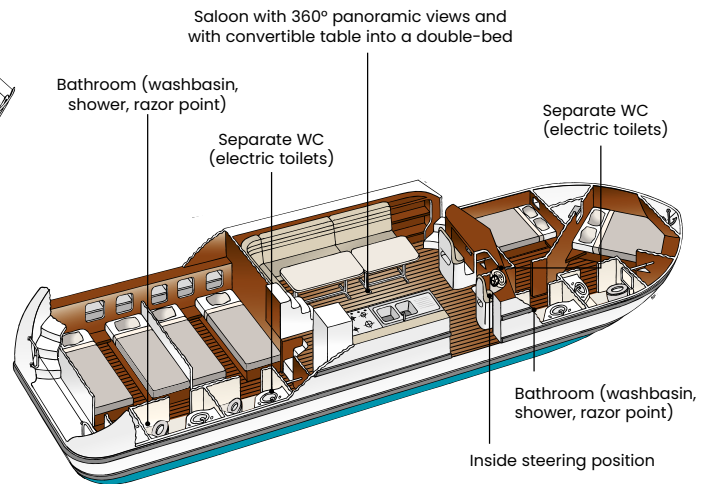

Saloon with 360° panoramic views and with convertible table into a double-bed

Bathroom (washbasin, shower, razor point)

Separate WC (electric toilets)

Separate WC (electric toilets)

Bathroom (washbasin, shower, razor point)

Inside steering position

KEY FACTS

- Private bathroom for each cabin
- Ideal for couples
- Front and rear terraces
- 2-10 people



Front terrace



Saloon Confort 1100



Cabin Confort 1350 / B

	Confort 900 DP	Confort 1100	Confort 1350 / Confort 1350 B
Maximum capacity	7 people	9 people	10 people
Capacity recommended	4 adults / 1 child	6 adults / 1 child	8 adults
Length / Width	8,85 x 3,40 m	11,10 x 3,40 m	13,50 x 3,80 m
ROOM LAYOUT			
Cabins	2 + saloon	3 + saloon	4 + saloon
Double-beds (140 x 190 cm)	2 + 1 saloon	3 + 1 saloon	1 saloon + 2 fixed 2 convertible into 4 single-beds
Single-bed (70 x 190 cm)	1	1	4 possibles
Bathroom / electric toilets	2	3	4
Saloon	9 m ²	10 m ²	14 m ²
KITCHEN EQUIPMENT			
220 L fridge (freezer)	●	●	●
2 ring-hob	●	●	-
4 ring-hob	-	-	●
Oven	● (Gril)	●	●
OTHER INTERIOR EQUIPMENT			
Heating	●	●	●
Radio, CD, MP3	●	●	●
Electrical connector 220 V on board	●	●	●
OTHER EXTERIOR EQUIPMENT			
Garden furniture	● (free, on request)	● (free, on request)	●
Bathing ladder	●	●	●
Double steering position	●	●	●
Stem propeller	-	-	C1350 : - C1350 B : ●
Water tank capacity	800 L	1200 L	1400 L
Fuel tank capacity	300 L	300 L	500 L

All photos and descriptions are non-contractual. We reserve the right to modify them without prior notice.

5/7 Comfort and equipment

Confort 900 DP



Recommended for 2 couples

- 2 cabins + convertible living room
- 2 showers / 2 Electric toilets

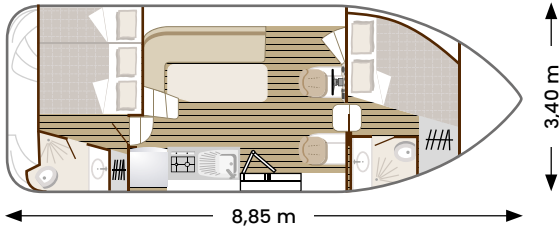

7/9 Comfort and equipment

Confort 1100



Recommended for 3 couples

- 3 cabins + convertible living room
- 3 showers / 3 Electric toilets

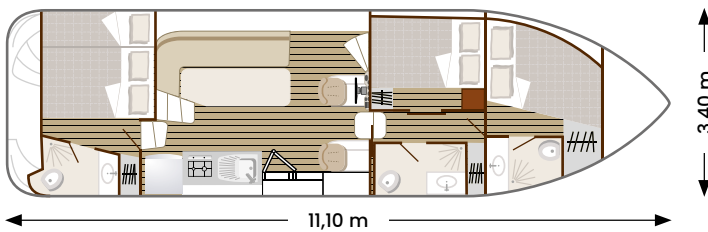

8/10 Comfort and equipment

Confort 1350



8/10 Comfort and equipment

Confort 1350 B



Recommended for 4 couples

- 4 cabins + convertible living room
- 4 showers / 4 Electric toilets

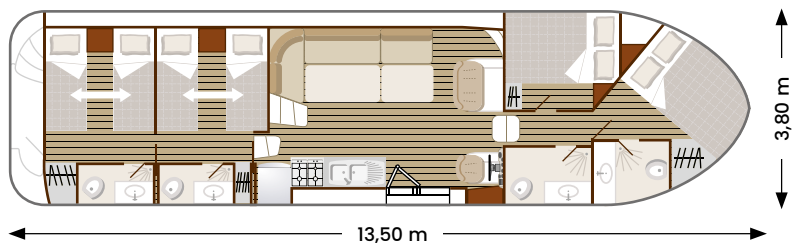

SEDAN RANGE

SEDAN N1170 - 8/10

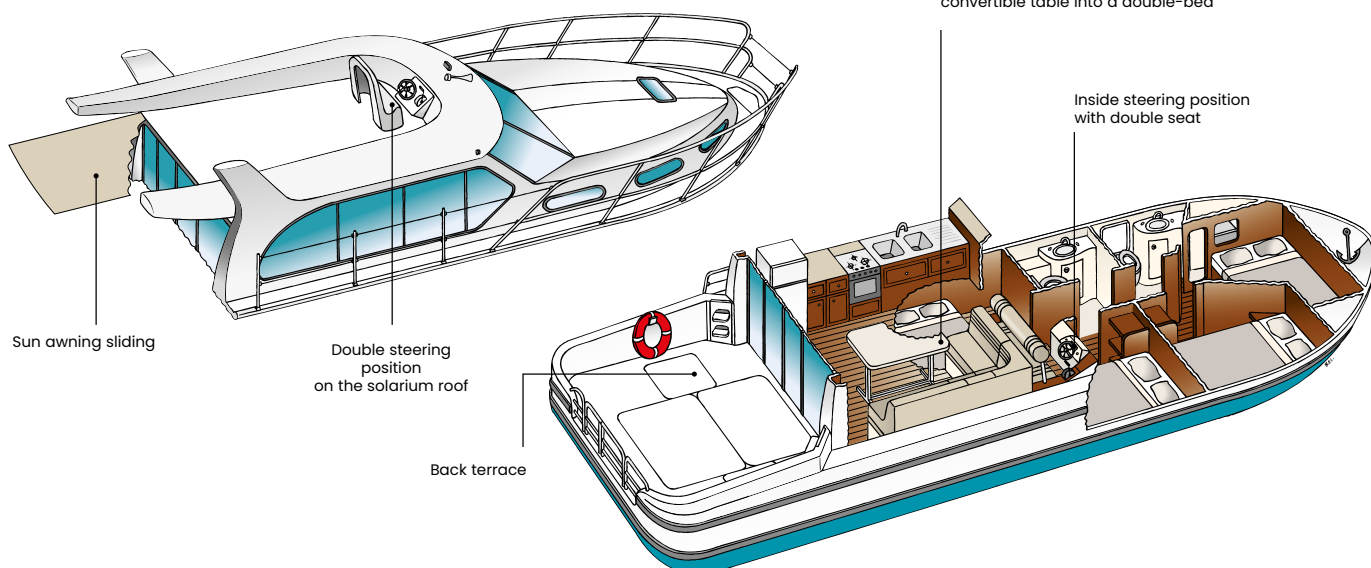

KEY FACTS

- Large living room & panoramic views
- Spacious rear terrace
- Ideal for families
- 2-12 people



Rear terrace Sedan Primo



Saloon Sedan N1000



Cabin Sedan Primo

	Sedan N800	Sedan Primo®	Sedan N1000	Sedan N1010
Maximum capacity	3 people	4 people	8 people	8 people
Capacity recommended	2 adults	2 adults	4 adults / 2 children	4 adults / 2 children
Length / Width	8 x 2,50 m	7,95 x 3,40 m	10 x 3,70 m	10 x 3,70 m
ROOM LAYOUT				
Cabins	1 + saloon	1 + saloon	3 + saloon	3 + saloon
Double-beds (140 x 190 cm)	1 + saloon	1 + 1 saloon	3 + 1 saloon	3 + saloon
Single-bed (70 x 190 cm)	-	-	-	-
Bathroom / toilets	1	1	2	2
Saloon	5 m ²	7 m ²	10 m ²	10 m ²
KITCHEN EQUIPMENT				
220 L fridge (freezer)	-	-	●	●
130 L fridge + freezer	-	●	-	-
56 L Fridge	●	-	-	-
3 ring-hob	-	-	●	●
2 ring-hob	●	●	-	-
Oven	-	●	●	●
OTHER INTERIOR EQUIPMENT				
Heating	●	●	●	●
Radio, CD, MP3	●	●	●	●
Electrical connector 220 V on board	-	●	-	-
OTHER EXTERIOR EQUIPMENT				
Garden furniture	● (free, on request)	● (free, on request)	●	●
Sun awning sliding	-	-	●	●
Bathing ladder	●	●	●	●
Double steering position	-	-	●	●
Water tank capacity	200 L	200 L	600 L	600 L
Fuel tank capacity	130 L	135 L	300 L	300 L

All photos and descriptions are non-contractual. We reserve the right to modify them without prior notice.

2/3 Comfort and equipment

Sedan N800

Recommended for 1 couple

- 1 cabin + convertible living room
- 1 shower / 1 toilets

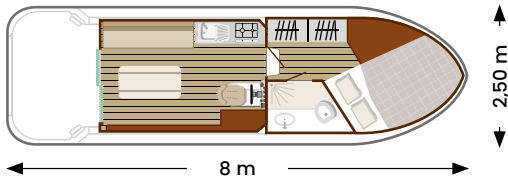

2/4 Comfort and equipment

Sedan Primo

Recommended for 1 couple or 1 couple + 2 children

- 1 cabin + convertible living room
- 1 shower / 1 toilets

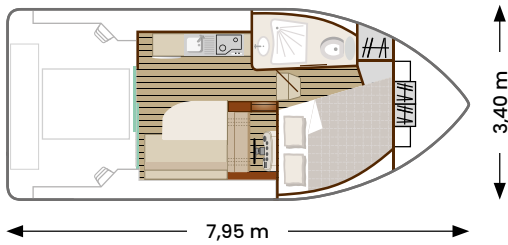

6/8 Comfort and equipment



Sedan N1000

Recommended for 4 adults and 2 children

- 3 cabins + convertible living room
- 2 showers / 2 toilets

Sedan N1010

Recommended for 4 adults and 2 children

- 3 cabins + convertible living room
- 2 showers / 2 toilets



Headroom above bunks: 100 cm maximum

Sedan N1000 & N1010 - Deck plan:
saloon table and seating convertible into a double-bed

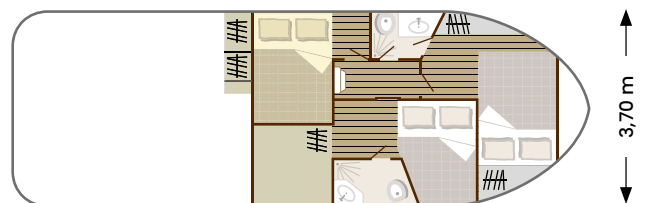
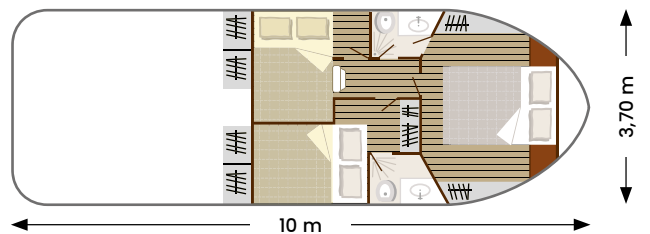
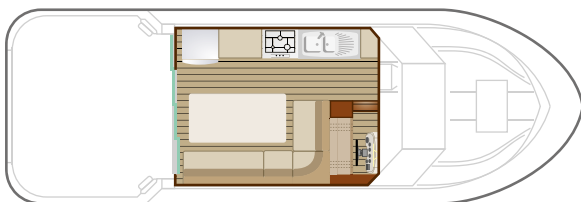

Full details on page 54



8/10 Comfort and equipment

Sedan N1160



Sedan N1160 N



Recommended for 4 adults and 4 children

- 4 cabins + convertible living room
- 2 showers / 2 toilets (+ 2 washbasins on 1160)

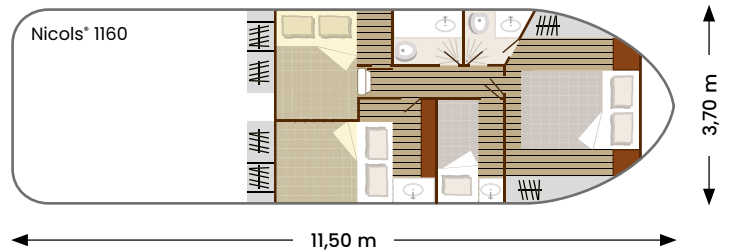

Sedan N1170



Recommended for 4 adults and 4 children

- 4 cabins + convertible living room
- 2 showers / 2 toilets

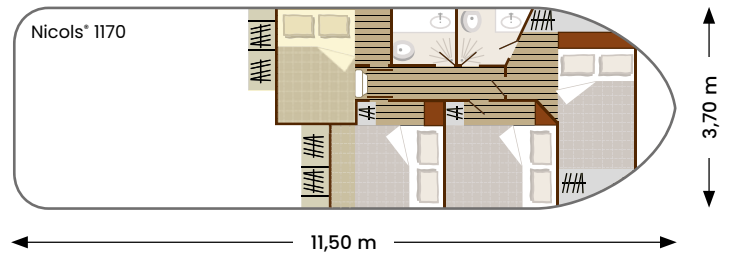

Headroom above bunks:
100 cm maximum

Sedan N1160 - N1160N & N1170

Deck plan: saloon table and seating convertible into a double-bed

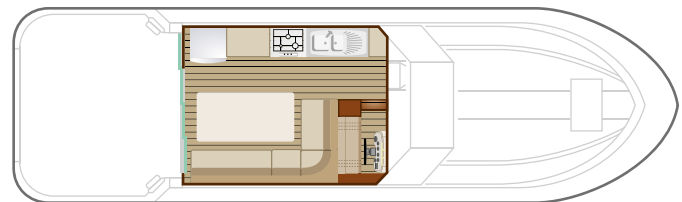

Full details on page 57

Sedan N1310



Full details on page 57

Recommended for 6 adults and 4 children

- 5 cabins + convertible living room
- 2 showers / 2 toilets

Headroom above bunks:
100 cm maximum

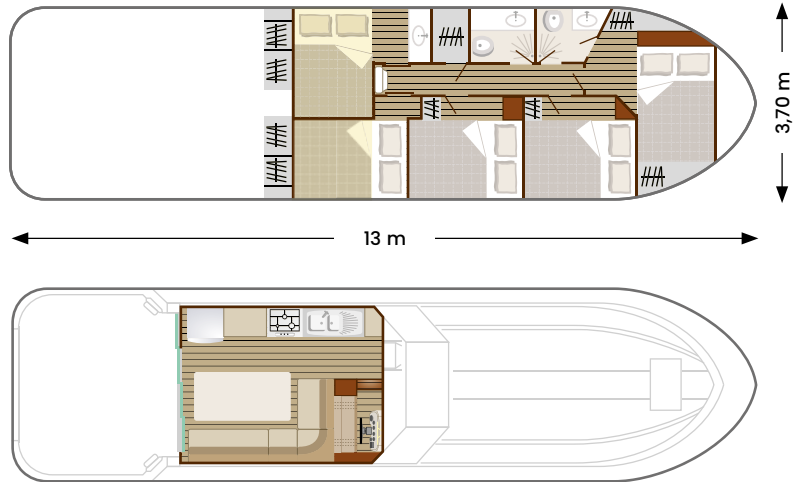

Sedan N1310 - Deck plan:
saloon table and seating convertible
into a double-bed



	Sedan N1160 / N1160N	Sedan N1170	Sedan N1310
Maximum capacity	10 people	10 people	12 people
Capacity recommended	4 adults / 4 children	4 adults / 4 children	6 adults / 4 children
Length / Width	11,50 x 3,70 m	11,50 x 3,70 m	13 x 3,70 m
ROOM LAYOUT			
Cabins	4 + saloon	4 + saloon	5 + saloon
Double-beds (140 x 190 cm)	3 + 1 saloon	4 + 1 saloon	5 + 1 saloon
Single-bed (70 x 190 cm)	2	-	-
Bathroom / toilets	2	2	2
Saloon	10 m ²	10 m ²	10 m ²
KITCHEN EQUIPMENT			
220 L fridge (freezer)	•	•	•
3 ring-hob	•	•	•
Oven	•	•	•
OTHER INTERIOR EQUIPMENT			
Heating	•	•	•
Radio, CD, MP3	•	•	•
Electrical connector 220 V on board	(N1160N only)	-	-
OTHER EXTERIOR EQUIPMENT			
Garden furniture	•	•	•
Sun awning sliding	•	•	•
Bathing ladder	•	•	•
Water tank capacity	•	•	•
Fuel tank capacity	750 L	750 L	900 L
Double steering position	300 L	300 L	300 L

RIVIERA RANGE

RIVIERA 920 - 6/8

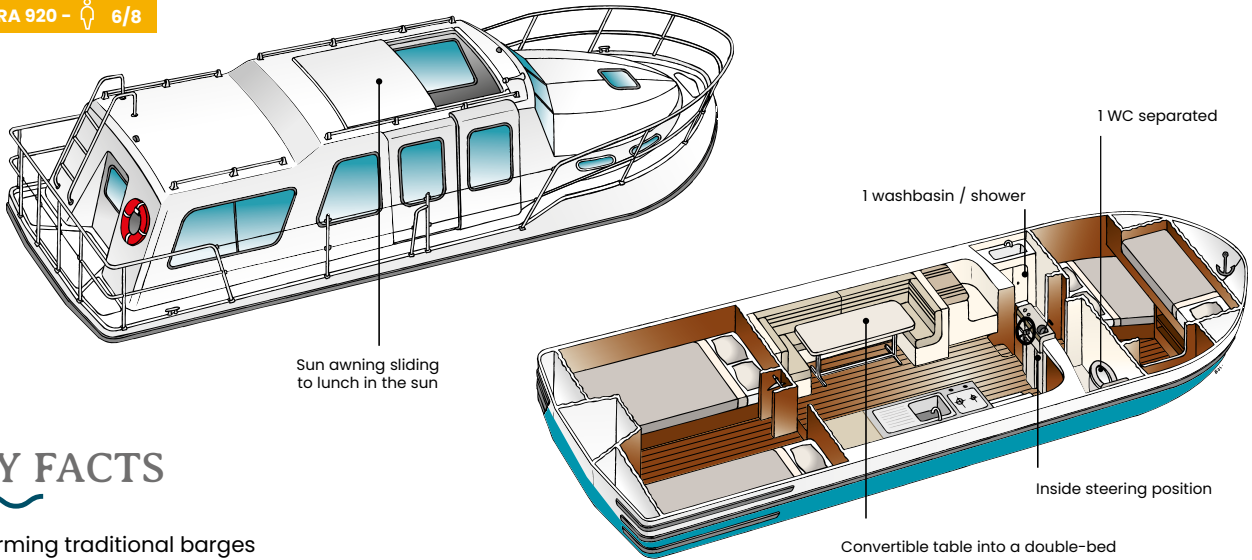

KEY FACTS

- Charming traditional barges
- Easy handling
- Ideal for a first cruise
- 4-8 people



Riviera 920



Saloon



Cabine

6/8 Comfort and equipment



Riviera 920

Recommended for 5 adults and 1 child

- 2 cabins + convertible living room
- 1 shower / 1 toilets

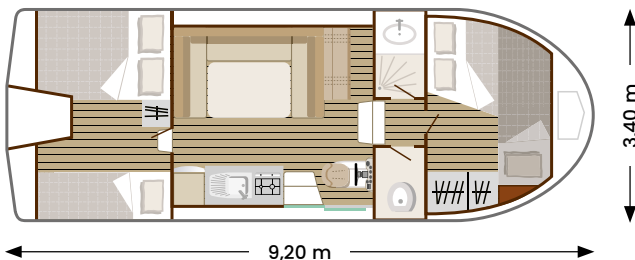

	Riviera 920
Maximum capacity	8 people
Capacity recommended	5 adults / 1 child
Length / Width	9,20 x 3,40 m
ROOM LAYOUT	
Cabins	2 + saloon
Double-beds (140 x 190 cm)	2 + 1 saloon
Single-bed (70 x 190 cm)	2
Bathroom / toilets	1 / 1
Saloon	8 m ²
KITCHEN EQUIPMENT	
100 L fridge - 2 ring-hob - Oven	•
OTHER INTERIOR EQUIPMENT	
Heating	•
Radio, CD, MP3	•
OTHER EXTERIOR EQUIPMENT	
Bathing ladder	•
Water tank capacity	380 L
Fuel tank capacity	180 L

All photos and descriptions are non-contractual. We reserve the right to modify them without prior notice.

OWN A NICOLS BOAT

Enjoy life on the waterways all year round!



SINCE WE STARTED IN 1986 OUR NICOLS SHIPYARD HAS PRODUCED NEARLY 700 CANAL BOATS IN A RANGE OF MODELS.



Many of these have been used and maintained at our network of bases that operate the holiday rental side of the business, **before being offered for sale second hand** to owners who are looking to have access to their own floating home all year round.

We also sell brand new boats. Here you can choose a bespoke boat design with options available for things such as colours, materials and onboard equipment. **Our design office is on hand to help you personalise your one-of-a-kind canal boat.**

Boat ownership is easy with Nicols! Our rental management programme sees us look after the upkeep and maintenance of your boat and provide mooring for it. You will get to enjoy several weeks of the year onboard while for the remainder of the season it will be offered for rental through our holidays business which in turn provides you with an additional guaranteed income.

To find out more about purchasing a Nicols boat, whether new, used or in our rental management programme, please contact us.



Édition 2025 | Crédits photos : © A. Duerst | © A. Le Doledec | © Adobe Stock | © Adobe Stock - Feesurf | © Adobe Stock - Heiko Zahn | © Adobe Stock - Puntostudiofoto Lda | © Adobe Stock - Pure life pictures | © Adobe Stock - Reindesign-sn | © Adobe Stock - S. Hermann | © Adobe Stock - Yasonia | © Agence Cameleon - H. Hote | © Air N. Bouyssi | © Anjou Navigation | © ARPT Alentejo | © Atelier Bos | © Atout France - A. Blondiaux | © B. Cowling | © Bengoesplaces | © BFCTourisme - A. Doire | © C. Richters | © CDT35 - M. Quincy | © CDT47 | © Charente Tourisme | © Charente Tourisme - S. Laval | © Château du Plessis Bourré | © CK Mariot Photography | © CMN Paris - P. Berthé | © Coteaux du Languedoc | © CRT Franche Comté | © CRT Franche Comté - J. Thiebaud | © CRT Franche-Comté - M. Joly | © CRT Midi Pyrénées - D. Viet | © CRTB - A. Lamoureux | © CRTB - E. Berthier | © D. Maizy | © D. Maugeudre | © David de Miguel Herrero | © Dina | © Drone Images Solutions | © F. Paulussen | © Fotolia | © Fotolia - Afanasia | © Fotolia - C. Calcagno | © Fotolia - E. Schittenhelm | © Fotolia - Fred34560 | © Fotolia - Kanuaq | © Fotolia - Kirsty Pargeter | © Fotolia - L. Andronov | © Fotolia - P. Bosseboeuf | © Fotolia - S. Weis | © Fotolia - Strikker | © Fotolia - Westfotos.de | © France Mag / Howorth | © G. Huet | © Groupe Salins | © Haute Garonne Tourisme - N. Lacomme | © Interview production | © Istock - Andres | © Istock - Borchee | © Istock - Pixieluxe | © Istock - Wundervisuals | © J. Barna - Bilia Photography | © J. Laliaux | © J.J. Bernier | © JAG Images - Tour Carbonniere | © Jowi Vermaal | © Les contours - destination Angers | © Lot Tourisme - C. Novello | © Lot tourisme - C. Seguy | © Lot Tourisme - D. Viet | © Luchtfoto | © M. Bricard | © M. Hellard | © Mayenne Tourisme - J. Damase | © Mayenne Tourisme - M. Guillon | © Navigation douce | © Nicolai | © Nicols | © Nicols - Arnoldi Design | © Nicols - M. Chauvin | © Nicols - Mahart | © Nicols - O. Chauvin | © Nicols - Ph. Benoit | © O. Friedrich | © OT Cahors | © OT Saintes | © P. Beltrami - Mayenne Tourisme | © P. De Rexel | © P. Mielcareck | © P. Pierrard | © P. Sahuquet | © Pat on Stock | © Picknick | © R. Ulrich | © S. Gaudard | © S. Godin | © S. Golub | © S. Ouzounoff | © Sarreguemesins Tourisme - T. Grun | © Seenland | © Smalltalk Mag & Webzine | © SMC6 - S. Baudouin | © Vallée de la Sarthe | © Ville d'Auxerre - J. Laliaux | © Ville de Dole | © Ville de Laval | © Ville du Mans - Gilles Moussé | © VMK Cindy | © Voyage à Nantes | © Walibi Sud-Ouest | © www.scharmuetzsee.de | © Y. Goux | © Pozitivo-Digital | © AdobeStock | © Gopro@simontrikaadventures | © Woudrichem Shutterstock | © Maccaigne | © Arnoldi | © Les Vignerons de Buzet | © CDT47 | © Damien Lachos | © Beaucaire | © Maison du riz. Design Graphique : BCC - www.bleucomcedre.com - Juin 2024

Follow us:

